

South East Asia & South Asia

It's Wonderful Fishing

2021 Fishing Tackle Catalogue

SHIMANO

CONTENTS

01 REELS

HAGANE	04
Spinning Reel Features	05-07
JDM Spinning	08-13
Export Spinning	14-20
Spinning Reel Maintenance Tips	21
Baitcast Reel Features	22-23
Baitcast	24-33
SW Overhead	34-37
Digital Control for Baitcast Reels	38
Baitcast/Overhead Maintenance Tips	39
Electric Reel Features	40-43
Electric Reel	44-49
Electric Reel Maintenance Tips	50
Glossary For Reels	51
Yumeya Parts	52-55

02 RODS

Rod Features	56-58
Jigging	59-66
Casting	67-69
Shore Cast	70
Boat	71-73
Bass	74-84
Galatama	85-86
3-Piece Surf	87-88
Telescopic Surf	89-90
Special Rods	91
Trolling Rods	92
Sephia Series	93-95

03 LIFESTYLE GEAR

Lifestyle Gear	96
Lifestyle Gear Technology	97
Fishing Lines	98-100
Fishing Lures and Jigs	101-112
Fishing Wear	113-115
Accessories	116-117

04 MAINTENANCE

Reel Maintenance Spray	118
------------------------	-----

05 WARRANTY

Warranty Information	119
----------------------	-----

Today is the day.

輝く水面の先には、自分だけの夢や憧れが潜んでいる。

想いは不変のままに、風が変わる、流れが変わる。

追い求めた感動に出会うのは、今日かもしれない。



HAGANE

**OUR GOAL,
ETERNALLY
SMOOTH REELING**

**YOU INSTANTLY KNOW
THE TRUE FEELING WHEN
CRANKING A SHIMANO,
THAT IS THE REAL VALUE
OF 'HAGANE'**



**HAGANE
GEAR**

HAGANE GEAR is produced using Shimano's cold forging technology, without any additional machining. This retains the integrity and strength of the material.



**MICROMODULE
II**

MICROMODULE II GEAR is an improved version with even smoother performance. Super-refined teeth provide ultra smooth transmission.



X-SHIP

X-SHIP is a two pint pinion gear support which creates a strong gearing foundation and maximizes power transmission from the handle to the rotor.



**HAGANE
BODY**

The highly rigid HAGANE BODY protect the gear's rotation performance from heavy load and shock.



LIGHT AND POWERFUL WINDING ENABLES ANGLERS TO LEAD THE GAME

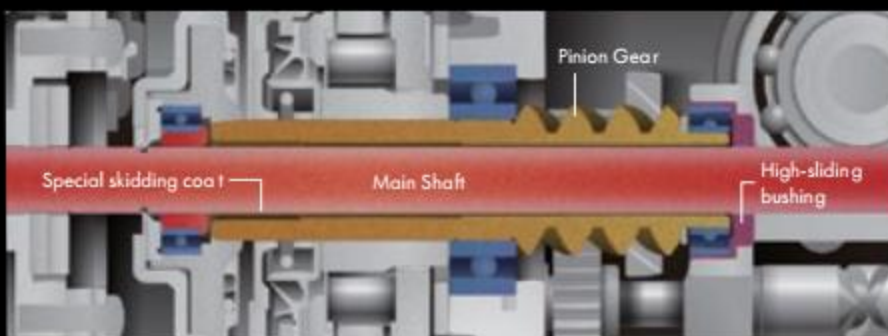

HANDLE ROTATION TORQUE REDUCED BY 30%*

* Based on internal test by Shimano

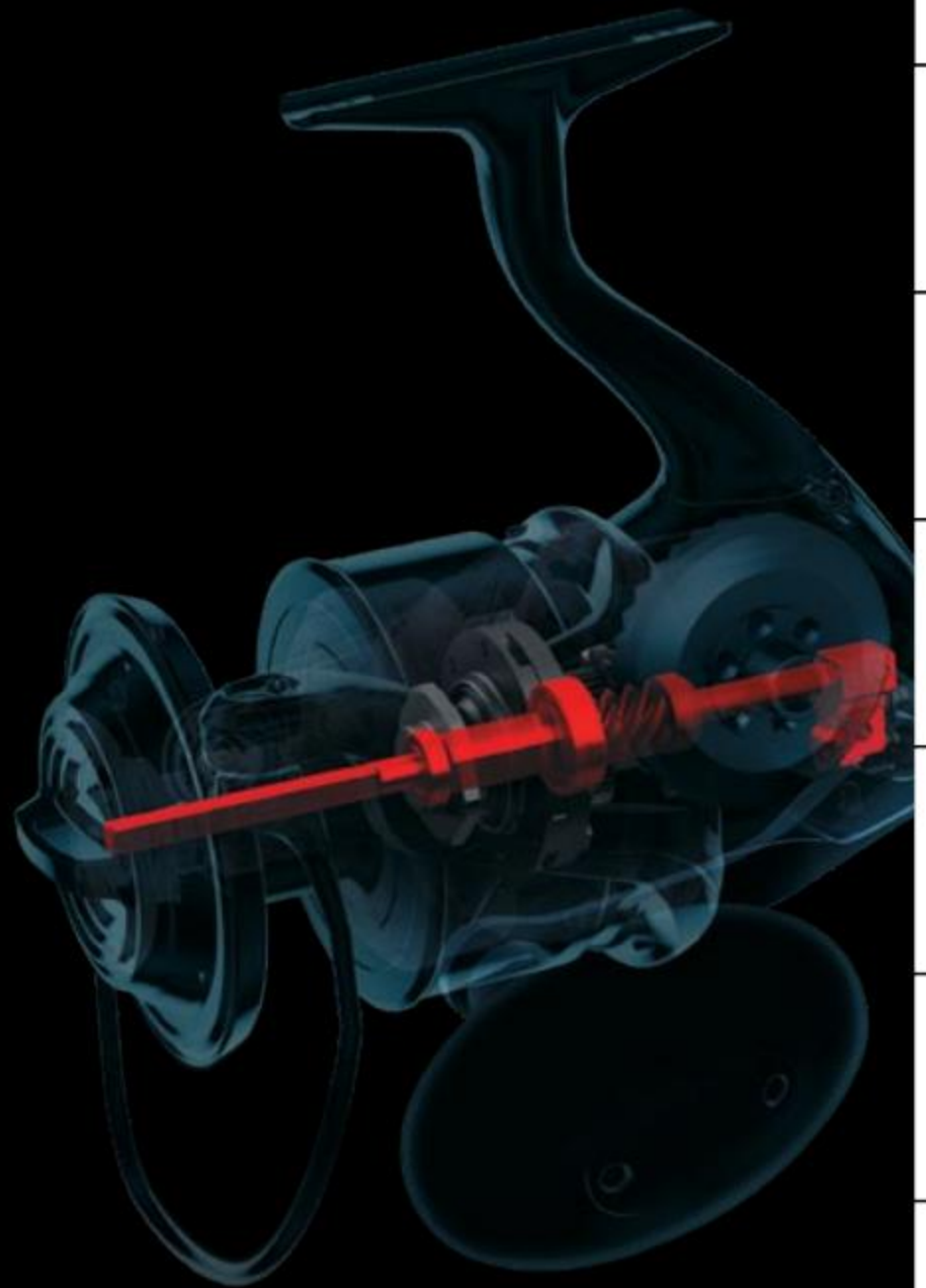

HEATSINK DRAG

TROUBLE FREE TOUGH DRAG CONQUERS THE HEAT AND ENABLES YOU TO CONTROL THE FIGHT WITH THE FISH!

Drag force retainment due to Heat Sink Drag: 50%* improvement!

Heat Sink Drag technology results in 30%* lower spool temperature.

* Based on internal test by Shimano

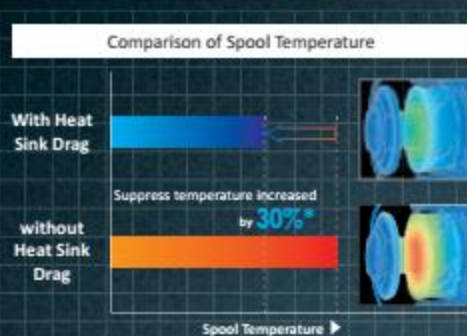
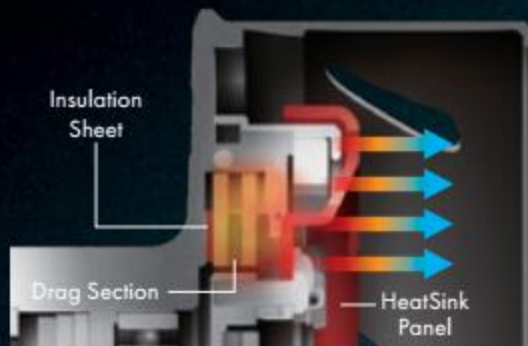

- REEL TECHNOLOGY
- JDM SPINNING REELS
- EXPORT SPINNING REELS
- BAITCAST REELS
- SW OVERHEAD REELS
- ELECTRIC REELS
- YUMEVU / GLOSSARY
- ROD TECHNOLOGY
- SALTWATER RODS
- BOAT RODS
- BASS RODS
- SPECIAL RODS
- LIFESTYLE GEAR

FEEL THE HOOK AS IT SETS WITH IMPROVED DRAG PERFORMANCE, A SOLID ROTOR THROUGH AND THROUGH

METAL ROTOR

Experience the featherweight of the ever-so rigid metal rotor made from Aluminium and Magnesium alloys. The high rigidity of the rotor will allow you to fish at ease without worries of distortion or deformation. Sturdy yet light, the reeling motion will feel unimaginably smooth through calculated moment of inertia of the rotor.



REDUCES INERTIA AND INCREASES RIGIDITY!

MAGNUMLITE ROTOR

The Magnumlite Rotor sets new standards in smooth rotation. Reduction in rotation inertia and increased rigidity, this rotor improves drag performance compared to previous designs.



SMOOTHNESS AND WATERPROOFNESS, TRUSTWORTHY STRUCTURE

X PROTECT

New Stella is equipped with X Protect. We achieved high waterproof performance by using water repellent coating and labyrinth structure to prevent water from entering the inner area of the reel.

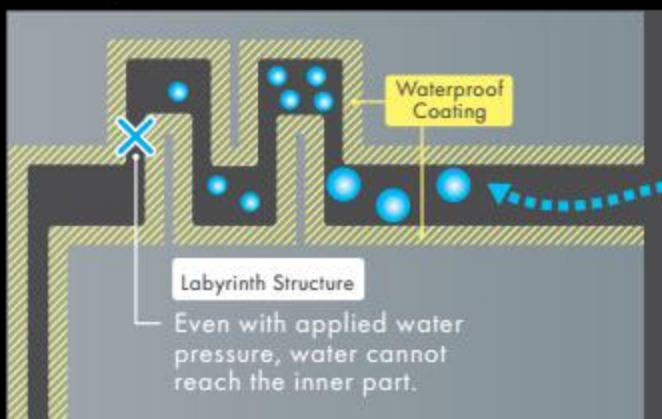

LARGE SIZED SALTWATER REELS

To achieve a greater level of water resistance on larger sized saltwater reels, a seal to sever off the route of seawater into the reel is used. The grease used not only improves the water resistance structure but also maintains a smooth and light reeling experience for the angler. X protect can be found on the line roller and stopper bearings. *Stopper bearings with X protect has IPX8-rated water resistance structure.

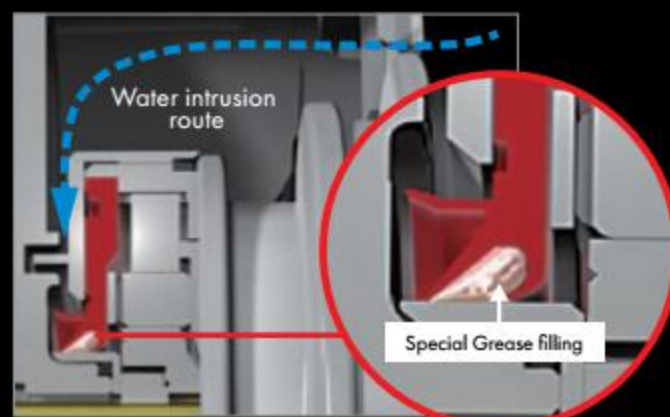



MICROMODULE II

SMOOTHNESS THROUGH AND THROUGH, A GEM AMONG GEARS

MICROMODULE GEAR II

We reviewed the teeth design from the most advanced designs, coming up with ideal tooth shape using Shimano unique manufacturing technology. Sound is reduced and smoothness is improved.

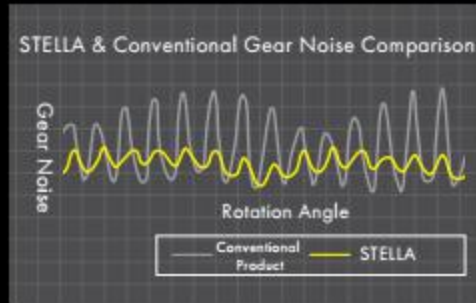

SILENTDRIVE

A SENSE OF UNITY THAT IS QUIET AND DETAILED

SILENT DRIVE

All driving parts are re-examined thoroughly, eliminating any minute gaps, looseness and shakes, improving the drive gear, worm shaft, worm shaft pins, worm shaft gear and so on. A new dimension of smoothness is achieved with the added comfort of quietness.

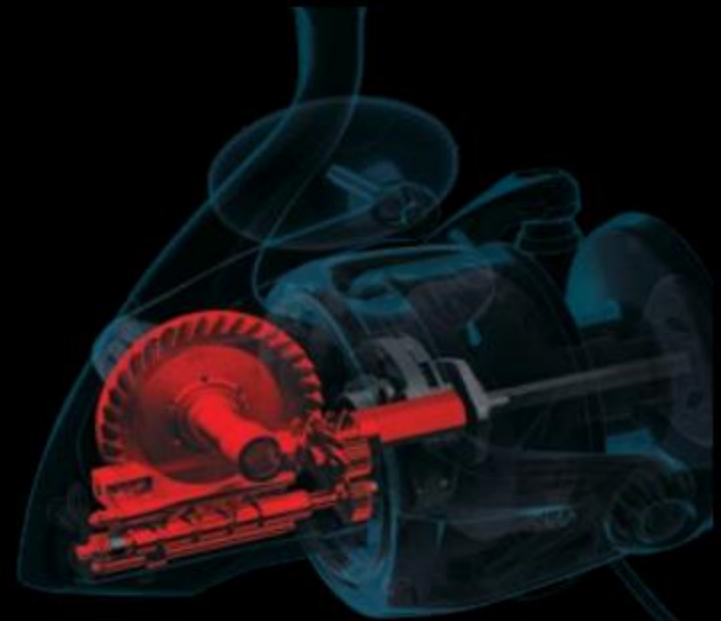

AR-C SPOOL

AR-C SPOOL

AR-C Spool lip design produces longer casting distances than a standard lip spool, while preventing backlashes and wind knots from forming.



RAPID FIRE DRAG

RAPID FIRE DRAG

When the drag knob is rotated, the change in drag force is more quickly adjusted along the drag curve than traditional drags.



ONE-PIECE BAIL

ONE-PIECE BAIL

One-Piece Bail allows the line to travel unimpeded to the line roller. Its seamless design reduces friction and the chance of tangles or cut to the bail arm.



FREE BODY

G FREE BODY

G Free Body is developed to shift the reel's centre of gravity closer to the rod and the angler's hand position which helps to reduce fatigue and enhances casting comfort.

PARALLEL BODY

PARALLEL BODY

The Parallel Body feature implicates that the spool is lined out parallel to the rod. This results in the reduction of line touching the rod and subsequently increases casting distance.

RIGID SUPPORT DRAG

RIGID SUPPORT DRAG

Rigid Support Drag eliminates spool movement and wobble, even at light drag settings. The result is an incredibly smooth drag even at extremely light settings.



TOUGH DRAG

X TOUGH DRAG

Incorporating large diameter drag washers at the base of the spool provides great stability. The Coil Wave Spring features steady elasticity at any compression level and little deformation under repeated compression resulting in precise drag adjustments

SHIELD

X SHIELD

By placing sealing gaskets in 12 critical locations throughout the rigid aluminium body, we are able to create a water resistant structure that can hold up against the toughest conditions.

STELLA

Ultimate Evolution.

Redesigning the teeth of the drive gear to fit perfectly against the Micromodule Gear II, even the slightest rattle is eliminated and the transition from stationary to intense winding is flawlessly silent with our latest Silent Drive technology. With X Protect guarding the body and line rollers, our achievements of the smoothest and most silent reel continues on in Stella.

Model Number	Line Capacity PE [no.-m]	Gear Ratio	Weight [g]	Max Drag [kg]	Bearings
1000	0.8-240, 1-190	5.1	170	3.0	12-1
C2000S	0.6-150, 0.8-110, 1-80	5.1	170	3.0	12-1
C2000SHG	0.6-150, 0.8-110, 1-80	6.1	170	3.0	12-1
2500	1-320, 1.2-270, 1.5-220	5.3	205	9.0	12-1
2500HG	1-320, 1.2-270, 1.5-220	6.0	205	9.0	12-1
C3000	1-400, 1.5-270, 2-200	5.3	210	9.0	12-1
C3000XG	1-400, 1.5-270, 2-200	6.4	210	9.0	12-1
4000	1-490, 1.5-320, 2-240	5.3	255	11.0	12-1
4000XG	1-490, 1.5-320, 2-240	6.2	255	11.0	12-1
C5000XG	1.5-400, 2-300, 3-200	6.2	260	11.0	12-1
C5000HG	1.5-400, 2-300, 3-200	5.8	260	11.0	12-1

CORESOLID



C3000XG



TWIN POWER

High Rigidity and Durability.

The Twin Power has been one of the top in Shimano's lineup for the past 30 years. To breakthrough, we had to create a reel that is stronger than before. To achieve this, we decided to equip the new Twin Power with a metal rotor to maximize rigidity of the reel. Paired with the HAGANE Body, this lineup has unparalleled durability and rigidity made specially for fights with pelagic. When cranking the all new Twin Power, some will sense familiarity as the lineup offers reels with Stella-grade smoothness and reeling experience. In addition, the long stroke spool helps in achieving greater casting distances. A trusty and tough reel suitable for use in multiple fields and situations, the Twin Power has evolved to new heights, marking the start of a new chapter.

Model Number	Line Capacity PE [no.-m]	Gear Ratio	Weight [g]	Max Drag [kg]	Bearings
1000	0.8-240, 1-190	5.1	175	3.0	9/1
C2000S	0.6-150, 0.8-110, 1-80	5.1	180	3.0	9/1
C2000SHG	0.6-150, 0.8-110, 1-80	6.1	180	3.0	9/1
2500	1-320, 1.2-270, 1.5-220	5.3	210	9.0	9/1
2500SHG	0.6-200, 0.8-150, 1-120	6.0	210	4.0	9/1
C3000	1-400, 1.5-270, 2-200	5.3	215	9.0	9/1
C3000XG	1-400, 1.5-270, 2-200	6.4	215	9.0	9/1
4000	1-490, 1.5-320, 2-240	5.3	255	11.0	9/1
4000PG	1-490, 1.5-320, 2-240	4.4	260	11.0	9/1
4000XG	1-490, 1.5-320, 2-240	6.2	260	11.0	9/1
C5000XG	1.5-400, 2-300, 3-200	6.2	260	11.0	9/1

CORESOLID



C3000XG



Vanquish

Lightness, Strength and Casting Distance like never seen before.

Unwavering at the top of the Magnumlite Series. From the body to the rotor and even the handle, it was a pursuit of making every part of the reel lighter than before. The result was an overwhelming success with the new models being much lighter than all its predecessors. With this new found lightness, the operability and overall feel of the reel has been greatly improved.

Model Number	Line Capacity PE [no.-m]	Gear Ratio	Weight [g]	Max Drag [kg]	Bearings
1000SSSPG	0.3-120, 0.4-90	4.6	145	3.0	11/1
C2000S	0.6-150, 0.8-110, 1-80	5.1	145	3.0	11/1
C2000SSS	0.3-140, 0.4-100, 0.6-80	5.1	145	3.0	11/1
C2000SHG	0.6-150, 0.8-110, 1-80	6.1	145	3.0	11/1
C2500SHG	0.6-200, 0.8-150, 1-120	6.0	155	3.0	11/1
C2500SXG	0.6-200, 0.8-150, 1-120	6.4	155	3.0	11/1
2500S	0.6-200, 0.8-150, 1-120	5.3	165	4.0	11/1
2500SHG	0.6-200, 0.8-150, 1-120	6.0	165	4.0	11/1
C3000SDH	0.6-200, 0.8-150, 1-120	5.3	175	9.0	11/1
C3000	1-400, 1.5-270, 2-200	5.3	170	9.0	11/1
C3000SDHG	0.6-200, 0.8-150, 1-120	6.0	175	9.0	11/1
C3000MHG	1-190, 1.2-150, 1.5-120	6.0	170	9.0	11/1
C3000XG	1-400, 1.5-270, 2-200	6.4	170	9.0	11/1
3000MHG	1-190, 1.2-150, 1.5-120	5.8	185	9.0	11/1
4000MHG	1.2-250, 1.5-200, 2-150	5.8	205	11.0	11/1
4000XG	1-490, 1.5-320, 2-240	6.2	200	11.0	11/1
C5000HG	1.5-400, 2-300, 3-200	5.8	220	11.0	11/1
C5000XG	1.5-400, 2-300, 3-200	6.2	220	11.0	11/1

TWIN POWER XD NEW

The strongest in the MGL series. A lighter and tougher Twin Power XD.

The New Twin Power XD is lighter than ever before while still retaining its logic-defying durability. Refining the reel's fundamental specs, performance is greatly improved with Shimano's latest technologies – Micromodule Gear II, Long Stroke Spool and Silent Drive. The tough drive gear system backed by carbon cross washers is coupled with the barrier coated spooling system (used in Stella SW spooling system!). This makes the reel so much tougher and comfortable across all models in the line-up. Experience the toughness of what Shimano proudly calls MGL's strongest!

Model Number	Line Capacity PE [no./m]	Gear Ratio	Weight [g]	Max Drag [kg]	Bearings
C3000HG	1-400, 1.5-270, 2-200	6.0	200	9.0	10/1
C3000XG	1-400, 1.5-270, 2-200	6.4	200	9.0	10/1
4000PG	1-490, 1.5-320, 2-240	4.4	245	11.0	10/1
4000HG	1-490, 1.5-320, 2-240	5.8	245	11.0	10/1
4000XG	1-490, 1.5-320, 2-240	6.2	245	11.0	10/1
C5000XG	1.5-400, 2-300, 3-200	6.2	245	11.0	10/1

CARDIFF C14+

A special tune developed for Ultra Light gamers. Stabilised outgoing line with the Rigid Support Drag technology, a fine tuned area drag and exhilarating drag sounds. These form the drag system on the reel which is targeted towards the Ultra-Light Fishing lovers. All models are equipped with the NEW Magnumlite Rotor.

Model Number	Line Capacity PE [no.-m]	Gear Ratio	Weight [g]	Max Drag [kg]	Bearings
1000S	0.6-140, 0.8-100, 1-70	5.0	170	3.0	9/1
1000SHG	0.6-140, 0.8-100, 1-70	6.0	170	3.0	9/1
C3000MHG	1-220, 1.2-150, 1.5-135	6.0	200	9.0	9/1

MGL
MAGNUMLITE



C3000XG

IGN GEAR	MICROMODULE II	SHIP	IGN BODY	MGL ROTOR	X PROTECT	SILENTDRIVE
FREE BODY	ARC-C SPOOL	C14+ ※1	LONG STROKE SPOOL	RIGID SUPPORT DRAG	A-RB	ONE-PIECE DRAG
油 O	※1 : Rotor material, handle material (C5000HG, C5000XG are aluminum)					

MGL
MAGNUMLITE



C5000XG

IGN GEAR	MICROMODULE II	SHIP	IGN BODY	MGL ROTOR	X PROTECT	SILENTDRIVE
FREE BODY	ARC-C SPOOL	C14+ ※1	LONG STROKE SPOOL	RIGID SUPPORT DRAG	A-RB	ONE-PIECE DRAG
油 O	※1 : Rotor material					

MGL
MAGNUMLITE



1000SHG

IGN GEAR	SHIP	MGL ROTOR	X PROTECT	ENDPROTECT	FREE BODY	ARC-C SPOOL
C14+ p	RIGID SUPPORT DRAG	A-RB	ONE-PIECE DRAG	油 O		

※1 : C3000MHG ※2 : 1000S, 1000SHG ※3 : Body and rotor material

REEL TECHNOLOGY

JDM SPINNING REELS

EXPORT SPINNING REELS

BAITCAST REELS

SW OVERHEAD REELS

ELECTRIC REELS

YUMENVA/ GLOSSARY

ROD TECHNOLOGY

SALTWATER RODS

BOAT RODS

BASS RODS

SPECIAL RODS

LIFESTYLE GEAR

STELLA SW

Absolute Power.

Shimano Stella SW Spinning Reels are the latest edition to the legacy of Stella Spinning Reels that have led the fishing world in durability, power and operability. Shimano builds on that tradition with cutting edge technologies bringing further unmatched strength, reliability and ease of use to serious saltwater anglers. Featuring Shimano's signature HAGANE Body, Stella SW boasts a highly rigid metal construction. At the heart of the reel, Shimano certified HAGANE Gears are cold forged for lasting durability and smoothness. For even better drag performance, Shimano's new Heat Sink Drag transfers heat away from the spool, reducing spool surface temperature by up to 100 degrees Fahrenheit.

Stella SW's IPX8 waterproof body along with X-Protect and X-Shield's water resistant construction in the line roller and roller bearing, guard your investment against the harsh elements of a saltwater environment so you can fish with confidence.

Model Number	Line Capacity PE [no.-m]	Gear Ratio	Weight [g]	Max Drag [kg]	Bearings
4000HG	1-490, 1.5-320, 2-240	5.7	355	11.0	12/1
4000XG	1-490, 1.5-320, 2-240	6.2	355	11.0	12/1
5000HG	2-350, 3-240, 4-170	5.7	420	13.0	13/1
5000XG	2-350, 3-240, 4-170	6.2	420	13.0	13/1
6000PG	2-440, 3-300, 4-210	4.6	425	13.0	13/1
6000HG	2-440, 3-300, 4-210	5.7	425	13.0	13/1
6000XG	2-440, 3-300, 4-210	6.2	425	13.0	13/1
8000HG	3-410, 4-300, 5-250	5.6	625	25.0	13/1
8000PG	3-410, 4-300, 5-250	4.9	625	25.0	13/1
10000PG	4-400, 5-300, 6-250	4.9	670	25.0	13/1
14000XG	6-300, 8-200, 10-165	6.2	675	25.0	13/1
14000PG	6-300, 8-200, 10-165	4.9	675	25.0	13/1
18000HG	5-500, 6-400, 8-300	5.7	875	28.0	13/1
20000PG	5-600, 6-500, 8-350	4.4	885	28.0	13/1
30000	8-600, 10-475, 12-375	4.4	975	25.0	13/1

TWIN POWER SW NEW

Challenge the impossible.

The inclusion of Infinity Drive reduces handle rotation torque by a maximum of 30% when compared to the previous series. Heat Sink Drag features in the 10000 and 14000 sizes to reduce the amount of heat transferred to the drag washers and line during the fight. The X-Protect seal and labyrinth structure repels water intrusion, with the line roller and clutch assembly, the mechanism is more than ten times more durable according to Shimano internal tests. The new striking silver and blue cosmetics have been paired up with a polished metal handle and power knob to finish the reel off superbly. Engineered to the highest standard for the world's hardest fighting saltwater species.

Model Number	Line Capacity PE [no./m]	Gear Ratio	Weight [g]	Max Drag [kg]	Bearings
4000XG	1-490, 1.5-320, 2-240	6.2	350	11.0	9/1
5000HG	2-350, 3-240, 4-170	5.7	415	13.0	10/1
5000XG	2-350, 3-240, 4-170	6.2	415	13.0	10/1
6000PG	2-440, 3-300, 4-210	4.6	420	13.0	10/1
6000HG	2-440, 3-300, 4-210	5.7	420	13.0	10/1
6000XG	2-440, 3-300, 4-210	6.2	420	13.0	10/1
8000PG	3-410, 4-300, 5-250	4.9	615	25.0	10/1
8000HG	3-410, 4-300, 5-250	5.6	615	25.0	10/1
10000PG	4-400, 5-300, 6-250	4.9	655	25.0	10/1
10000HG	4-400, 5-300, 6-250	5.6	655	25.0	10/1
14000PG	6-300, 8-200, 10-165	4.9	660	25.0	10/1
14000XG	6-300, 8-200, 10-165	6.2	660	25.0	10/1



14000XG



*1: 10000PG, 14000XG, 14000PG, 18000HG, 20000PG, 30000 only
 *XG = Extra High Gear specification, HG = High Gear specification, PG = Power Gear specification.
 *8000 to 30000 bail does not return.
 *Equivalent to IPXB (body)
 *There is no stopper switching mechanism.
 *8000 is for PE line only



14000XG



※1 : 10000PG, 10000HG, 14000PG, 14000XG only ※2 : Excluding 4000XG
 *XG = Extra High Gear specification, HG = High Gear specification, PG = Power Gear specification.
 *Bail of 8000 to 14000 does not return.
 *Equivalent to IPXB (body)
 *There is no stopper switching mechanism.
 *8000 is for PE line only

STRADIC SW NEW

Specs designed to cater for exciting SW game!

Light cranking feel yet strong build and power, fight with fish on your terms with the Infinity Drive technology! X protect shuts out water from entering the inner chambers of the reel, making the reel more durable than ever before. A truly strong and durable fighter for the next-level off shore game!

Model Number	Line Capacity PE [no./m]	Gear Ratio	Weight [g]	Max Drag [kg]	Bearings
4000HG	1-490, 1.5-320, 2-240	5.8	300	11.0	6/1
4000XG	1-490, 1.5-320, 2-240	6.2	300	11.0	6/1
5000PG	2-350, 3-240, 4-170	4.6	430	12.0	6/1
5000XG	2-350, 3-240, 4-170	6.2	430	12.0	6/1
6000PG	2-440, 3-300, 4-210	4.6	440	12.0	6/1
6000HG	2-440, 3-300, 4-210	5.7	440	12.0	6/1
6000XG	2-440, 3-300, 4-210	6.2	440	12.0	6/1
8000PG	3-410, 4-300, 5-250	4.9	650	13.0	6/1
8000HG	3-410, 4-300, 5-250	5.6	645	13.0	6/1
10000HG	4-400, 5-300, 6-250	5.6	660	13.0	6/1

SPHEROS SW

Power and Toughness.

Massive fish? No problem!

The latest addition to the Spheros SW range comes with power and toughness which will not lose fights against larger fish. The core of this compact SW reel is the cold forged HAGANE gear and its HAGANE body, providing gear strength and smoothness demanded by anglers. With little play in the handle along with highly durable drag washers made of carbon, anglers can feel at ease when fighting against big fish at sea.

Model Number	Line Capacity PE [no./m]	Gear Ratio	Weight [g]	Max Drag [kg]	Bearings
3000XG	1-400, 1.5-270, 2-200	6.2	255	9.0	3/1
4000HG	1-490, 1.5-320, 2-240	5.8	280	11.0	3/1
4000XG	1-490, 1.5-320, 2-240	6.2	280	11.0	3/1

SPHEROS SW

The Spheros SW is Shimano's entry level saltwater spinning reel and contains many features found on high end models such as X-ship, X-Shield and X-Protect.

Model Number	Line Capacity PE [no./m]	Gear Ratio	Weight [g]	Max Drag [kg]	Bearings
5000HG	2-350, 3-240, 4-170	5.7	495	10.0	4/1
6000HG	2-440, 3-300, 4-210	5.7	505	10.0	4/1
6000PG	2-440, 3-300, 4-210	4.6	505	10.0	4/1
8000HG	3-410, 4-300, 5-250	5.6	750	12.0	4/1
8000PG	3-410, 4-300, 5-250	4.9	750	12.0	4/1



5000XG



※1 : Excluding 4000HG, 4000XG ※2 : 4000HG, 4000XG only
 *XG = Extra High Gear specification, HG = High Gear specification, PG = Power Gear specification.
 *Bail of 8000 to 10000 bail does not return.
 *Equivalent to IPXB (excluding body and 4000)
 *There is no stopper switching mechanism.
 *8000 is for PE line only



4000XG



※1 : Body Only



4000XG



*HG = High Gear specification, PG = Power Gear specification.
 *Equivalent to IPXB (body).
 *The bail does not return.
 *There is no stopper switching mechanism.

BULL'S EYE

Built specifically as a long casting surf and rock fishing reel, this reel was intentionally beefed up in all aspects to make it rugged, reliable and a pleasure to fish with. Packed with features such as SARB+1 Roller Clutch, a deep CF spool, one piece bail, direct maintenance port and anti-line foiling guard, you know that you can trust this reel to deliver the performance you need.

Model Number	Line Capacity PE [no.-m]	Gear Ratio	Weight [g]	Max Drag [kg]	Bearings
5050	3-225, 4-175, 5-140	4.3	445	12.0	5/1
5080	5-225, 6-185, 8-140	4.3	445	12.0	5/1
9100	6-235, 8-175, 10-140	3.5	540	20.0	5/1
9120	8-200, 10-160, 12-130	3.5	540	20.0	5/1

POWER AERO SPIN POWER

TWIN DRAG

These reels come from the renowned Power Aero range of reels known for their highly rigid aluminium body that results in little energy loss due to flexing of reel body. Gears are made by Shimano well known cold forged techniques to ensure that its high quality and last much longer than traditional stamped gears. ARC spool ensures that the line flows out smoothly off the spool when casting for maximum distance.

Model Number	Line Capacity PE [no.-m]	Gear Ratio	Weight [g]	Max Drag [kg]	Bearings
Standard [Size : 3] Free Spool [Size :5]	1.5-250, 2-200, 3-130 3-225, 4-175, 5-140	3.5	560	19.0	7/1
Thick [Size : 5] Free Spool [Size :8]	3-225, 4-175, 5-140 5-225, 6-185, 8-140	3.5	560	19.0	7/1
Thick+ [Size : 8] Free Spool [Size :10]	5-225, 6-185, 8-140 6-235, 8-175, 10-140	3.5	565	19.0	7/1

POWER AERO PROSURF

TWIN DRAG

Big pit surfcast reels are the top choices for anglers looking for long cast off the shore. This latest generation weighs in at 600g, a 75g reduction from the previous generation.

Model Number	Line Capacity PE [no.-m]	Gear Ratio	Weight [g]	Max Drag [kg]	Bearings
Standard [Size : 3] Free Spool [Size :5]	1.5-250, 2-200, 3-130 3-225, 4-175, 5-140	3.5	600	19.0	5/1
Thick [Size : 5] Free Spool [Size :8]	3-225, 4-175, 5-140 5-225, 6-185, 8-140	3.5	600	19.0	5/1
Thick+ [Size : 8] Free Spool [Size :10]	5-225, 6-185, 8-140 6-235, 8-175, 10-140	3.5	600	19.0	5/1

Activecast

The Activecast Surf reel is the perfect choice with an affordable price tag for the beginner surf angler. This reel is suitable for distance casting with a respectable retrieve rate of 3.8:1

Model Number	Line Capacity PE [no./m]	Gear Ratio	Weight [g]	Max Drag [kg]	Bearings
1050	3-255, 4-175, 5-140	3.8	650	15.0	4/1
1060	4-225, 5-185, 6-140	3.8	650	15.0	4/1
1080	5-225, 6-185, 8-140	3.8	650	15.0	4/1
1100	6-235, 8-175, 10-130	3.8	650	15.0	4/1
1120	8-200, 10-160, 12-130	3.8	650	15.0	4/1



9100



#1 : 9100, 9120 #2 : Body and rotor material (5050, 5080)



Thick



Thick



1100



Sephia C14+

Magnumlite Rotor creates a smoother rotation, better controllability and ease to create fine action in your lures. It is also more sensitive to allow the Egi to stay at a certain depth. Despite the lighter weight, reel strength is maintained. Coupled with HAGANE gears, it is the perfect blend of power and sensitivity.

The X-Ship gear system is the icing on the cake, providing smooth cranking after trip!

Model Number	Line Capacity PE [no.-m]	Gear Ratio	Weight [g]	Max Drag [kg]	Bearings
C3000S	0.6-200, 0.8-150, 1-110	5.0	185	9.0	9-1
C3000SHG	0.6-200, 0.8-150, 1-110	6.0	185	9.0	9-1
C3000SDH	0.6-200, 0.8-150, 1-110	5.0	195	9.0	9-1
C3000SDHGH	0.6-200, 0.8-150, 1-110	6.0	195	9.0	9-1

Sephia SS

Sephia SS, the latest addition to the Sephia line-up allows for a smooth cranking experience which is made possible with the HAGANE gears. It is also equipped with Magnumlite (MGL) rotor allowing for a low moment of inertia as well as Core Protect technology to protect the reel from Saltwater.

Integrated bail with no joints - Beautiful, trouble free and gentle on the line!

Model Number	Line Capacity PE [no.-m]	Gear Ratio	Weight [g]	Max Drag [kg]	Bearings
C3000S	0.6-200, 0.8-150, 1-110	5.0	205	9.0	7/1
C3000SHG	0.6-200, 0.8-150, 1-110	6.0	205	9.0	7/1
C3000SDH	0.6-200, 0.8-150, 1-110	5.0	220	9.0	7/1
C3000SDHGH	0.6-200, 0.8-150, 1-110	6.0	220	9.0	7/1

Sephia BB

Fishing without overlooking the functions of high end models!

The Sephia BB surpasses the limitations of an entry level reel. Other than being able to withstand the hard and quick jerks required during eging, this reel is equipped with HAGANE gears which guarantee durability of the reel and comfort during retrieving.

Features most commonly found on more expensive models such as Core Protect, Rapid Fire Drag and One Piece Bail are all embodied in this reel.

Model Number	Line Capacity PE [no.-m]	Gear Ratio	Weight [g]	Max Drag [kg]	Bearings
C3000S	0.6-200, 0.8-150, 1-110	5.0	235	9.0	5/1
C3000SHG	0.6-200, 0.8-150, 1-110	6.0	235	9.0	5/1
C3000SDH	0.6-200, 0.8-150, 1-110	5.0	250	9.0	5/1
C3000SDHGH	0.6-200, 0.8-150, 1-110	6.0	250	9.0	5/1

MGL
MAGNUMLITE



C3000S



*1: Body, rotor and handle material

MGL
MAGNUMLITE



C3000S



*1: Rotor material

CORESOLID



C3000S



*HG = High Gear specification, S = Shallow Spool specification, DH = Double Handle specification, C = Compact Body
*There is no stopper switching mechanism.

SUSTAIN

The Sustain is an all-rounded front drag spinning reel with exciting new features. Most important feature is the X-Protect technology which is used to protect the important inner reel parts. X-Protect features water resistance and a special labyrinth structure in order to keep water out of the reel body.

Model Number	Power Pro Capacity [lb-yd]	Gear Ratio	Weight [g]	Max Drag [kg]	Bearings
2500	6-200, 8-140, 10-120	5.0	235	5.0	8/1
2500HG	6-200, 8-140, 10-120	6.0	235	6.0	8/1
C3000HG	6-230, 8-170, 10-140	6.0	225	6.0	8/1
3000XG	10-235, 20-145, 40-110	6.2	225	6.0	8/1
4000	8-240, 10-200, 12-160	4.8	280	4.8	8/1
4000XG	8-240, 10-200, 12-160	6.2	285	6.2	8/1
C5000XG	10-240, 12-195, 14-165	6.2	285	6.2	8/1

VANFORD NEW

Super Fast!

The all new Vanford is designed to become the ultimate finesse fishing reel with a super-fast start up. Replacing the iconic Stradic Ci4+, this reel is equipped with a range of technology upgrades that sets the Vanford apart. Still drawing upon a lightweight Ci4+ body construction, the new MGL rotor makes the reel 48% lighter to turn when compared to a standard rotor design. X-Protect provides high-level water resistance.

Model Number	Power Pro Capacity [lb-yd]	Gear Ratio	Weight [g]	Max Drag [kg]	Bearings
500	5-135, 8-105, 10-65	5.6	140	2.5	6/1
1000	10-95, 15-75, 20-65	5.1	150	3.0	7/1
C2000S	3-125, 4-105, 5-90	5.1	150	3.0	7/1
C2000HG	10-140, 15-115, 20-95	6.1	150	3.0	7/1
C2000SHG	3-125, 4-105, 5-90	6.1	150	3.0	7/1
2500	10-150, 15-145, 30-100	5.3	180	9.0	7/1
2500HG	10-150, 15-145, 30-100	6.0	180	9.0	7/1
2500SHG	5-140, 8-120, 10-85	6.0	175	4.0	7/1
C3000	10-200, 20-140, 40-105	5.3	180	9.0	7/1
C3000HG	10-200, 20-140, 40-105	6.0	180	9.0	7/1
C3000XG	10-200, 20-140, 40-105	6.4	180	9.0	7/1
4000	15-230, 30-180, 50-120	5.3	215	11.0	7/1
4000XG	15-230, 30-180, 50-120	6.2	215	11.0	7/1
C5000XG	20-260, 30-235, 40-185	6.2	220	11.0	7/1

STRADIC

Featuring Silent Drive and Micromodule Gear II, the Stradic's reeling performance now approaches flagship level. For the first time in Stradic's class, Shimano has implemented a Long Stroke Spool for improved casting distance. Durability has been further improved by raising gear strength and adopting X PROTECT water resistance.

Model Number	Power Pro Capacity [lb-yd]	Gear Ratio	Weight [g]	Max Drag [kg]	Bearings
1000S	3-115, 4-95, 5-80	5.1	185	3.0	6-1
1000	10-95, 15-85, 20-65	5.0	185	3.0	6-1
1000HG	10-95, 15-85, 20-65	6.0	185	3.0	6-1
C2000S	3-125, 4-105, 5-90	5.1	185	3.0	6-1
C2000SHG	3-125, 4-105, 5-90	6.1	185	3.0	6-1
2500	10-150, 15-145, 30-100	5.0	220	9.0	6-1
2500S	5-140, 8-120, 10-85	5.3	220	4.0	6-1
2500HG	10-150, 15-145, 30-100	6.0	225	9.0	6-1
C3000	10-200, 20-140, 40-105	5.0	225	9.0	6-1
C3000HG	10-200, 20-140, 40-105	6.0	225	9.0	6-1
C3000XG	10-200, 20-140, 40-105	6.4	225	9.0	6-1
4000	15-280, 30-170, 50-150	4.8	280	11.0	6-1
4000XG	15-280, 30-170, 50-150	6.2	280	11.0	6-1
C5000XG	20-260, 30-235, 40-185	6.2	295	11.0	6-1

MGL MAGNUMLITE



C3000HG



*XG - Extra High Gear specification, HG - High Gear specification, C - Compact Body
*Line clip not available on C5000XG Spool
*There is no stopper switching mechanism.

MGL MAGNUMLITE



2500SHG



※ 1: Body, rotor and handle material

CORESOLID



C3000XG



ULTEGRA NEW

The sleeping giant rests no longer. The new Ultegra is a feature-packed powerhouse, offering premium performance for all anglers.

Model Number	Power Pro Capacity [lb/yd]	Gear Ratio	Weight [g]	Max Drag [kg]	Bearings
1000	10-95,15-75,20-65	5.1	180	3.0	5/1
C2000S	3-125,4-105,5-90	5.1	185	3.0	5/1
C2000HG	10-140,15-115,20-95	6.1	185	3.0	5/1
C2000SHG	3-125,4-105,5-90	6.1	185	3.0	5/1
2500	10-150,15-145,30-100	5.3	225	9.0	5/1
2500HG	10-150,15-145,30-100	6.0	225	9.0	5/1
2500SHG	5-140,8-120,10-85	6.0	220	4.0	5/1
C3000	10-200,20-140,40-105	5.3	225	9.0	5/1
C3000HG	10-200,20-140,40-105	6.0	225	9.0	5/1
C3000XG	10-200,20-140,40-105	6.4	225	9.0	5/1
4000	15-230,30-180,50-120	5.3	270	11.0	5/1
4000XG	15-230,30-180,50-120	6.2	270	11.0	5/1
C5000XG	20-260,30-235,40-185	6.2	285	11.0	5/1

NASCI

The Nasci is a general purpose all-round fishing reel that is designed to feel at home either fishing in freshwater or saltwater shore fishing.

Model Number	Line Capacity PE [no.-m]	Gear Ratio	Weight [g]	Max Drag [kg]	Bearings
500	5-135, 8-105, 10-65	5.6	175	3.0	3/1
1000	15-85, 20-65	5.0	215	3.0	4/1
C2000S	0.6-150, 0.8-110, 1-80	5.0	220	3.0	4/1
C2000HGS	0.6-150, 0.8-110, 1-80	6.0	220	3.0	4/1
2500	15-145, 30-100	5.0	250	9.0	4/1
2500HGS	0.6-200, 0.8-150, 1-110	6.2	250	4.0	4/1
C3000	20-140, 40-105	5.0	250	9.0	4/1
C3000HG	20-140, 40-105	6.2	250	9.0	4/1
4000	30-170, 50-150	4.7	295	11.0	4/1
4000XG	20-205, 50-120	6.2	295	11.0	4/1
C5000XG	20-205, 50-120	6.2	300	11.0	4/1

SAHARA

Now with HAGANE gears and G Free Body the Sahara range of reels is tougher, lighter, smoother and stronger!

Model Number	Power Pro Capacity [lb-yd]	Gear Ratio	Weight [g]	Max Drag [kg]	Bearings
500	5-135, 8-105, 10-65	5.6	175	3.0	3/1
1000	15-85, 20-65	5.0	215	3.0	4/1
2500	10-150, 15-145, 30-100	5.0	250	9.0	4/1
C3000	10-200, 40-140, 40-105	5.0	250	9.0	4/1
C3000HG	10-200, 40-140, 40-105	6.2	250	9.0	4/1
4000	15-280, 30-170, 50-150	4.7	295	11.0	4/1
4000XG	15-280, 30-170, 50-150	6.2	295	11.0	4/1
C5000XG	20-220, 30-200, 40-160	6.2	300	11.0	4/1

SEDONA

Our Sedona range of reels just got a whole lot tougher with the addition of HAGANE gear and a G Free Body!

Model Number	Power Pro Capacity [lb-yd]	Gear Ratio	Weight [g]	Max Drag [kg]	Bearings
500	5-135, 8-105, 10-65	5.6	175	3.0	3-1
1000	15-85, 20-65	5.0	215	3.0	3-1
2500	10-150, 15-145, 30-100	5.0	245	4.0	3-1
2500HG	10-150, 15-145, 30-100	6.2	245	4.0	3-1
C3000	10-200, 40-140, 40-105	5.0	250	9.0	3-1
C3000HG	10-200, 40-140, 40-105	6.2	250	9.0	3-1
4000	15-280, 30-170, 50-150	4.7	295	11.0	3-1
4000XG	15-280, 30-170, 50-150	6.2	295	11.0	3-1
C5000XG	20-220, 30-200, 40-160	6.2	300	11.0	3-1
6000	30-290, 50-195, 65-140	4.6	425	10.0	3-1
8000	40-340, 50-265, 65-215	4.9	600	11.0	3-1

CORESOLID



C3000



*XG = Extra High Gear, HG = High Gear specification, S = Shallow Spool specification, C = Compact Body
*There is no stopper switching mechanism.



C3000HG



C3000HG



6000



※1: Excluding 500

REEL TECHNOLOGY

JDM SPINNING REELS

EXPORT SPINNING REELS

BAITCAST REELS

SW OVERHEAD REELS

ELECTRIC REELS

YUMENA/ GLOSSARY

ROD TECHNOLOGY

SALTWATER RODS

BOAT RODS

BASS RODS

SPECIAL RODS

LIFESTYLE GEAR

NEXAVE

The Nexave spin reels represent great value for money for an entry level series, perfect for newcomers and kids who need the right start in fishing. An XT-7 body keeps weight down, while 3 shielded stainless steel ball bearings and 1 roller bearing make winding the single piece aluminium handle as effortless as can be.

Model Number	Line Capacity PE [no./m]	Gear Ratio	Weight [g]	Max Drag [kg]	Bearings
1000	10/95, 15/85, 20/65	5.0	215	3.0	3/1
2500	10/150, 15/145, 30/100	5.0	255	4.0	3/1
2500HG	10/150, 15/145, 30/100	6.2	255	4.0	3/1
C3000	10/200, 20/140, 40/105	5.0	260	8.5	3/1
C3000HG	10/200, 20/140, 40/105	6.2	260	8.5	3/1
4000	15/280, 30/170, 50/150	5.2	325	8.5	3/1
4000HG	15/280, 30/170, 50/150	5.8	325	8.5	3/1
C5000HG	20/220, 30/200, 40/160	5.8	320	8.5	3/1
6000	30-285, 50-185, 65-135	4.9	595	8.0	3/1
8000	40-300, 50-255, 65-185	4.9	580	8.0	3/1

CATANA

Catana FD offers precision, power and performance for the budget minded angler. Propulsion Line Management system offers trouble free casting for a stress free day on the water. Lighter than the previous generation, users will also experience less fatigue during fishing.

Model Number	Power Pro Capacity [lb/yd]	Gear Ratio	Weight [g]	Max Drag [kg]	Bearings
1000	10-95,15-85,20-65	5.0	215	3.0	2/1
2500	10-150,15-145,30-100	5.0	260	4.0	2/1
4000	15-280,30-170,50-150	5.2	335	8.5	2/1
C3000HG	10-200,20-140,40-105	6.2	260	8.5	2/1
2500HG	10-150,15-145,30-100	6.2	260	4.0	2/1
C3000	10-200,20-140,40-105	5.0	260	8.5	2/1
4000HG	15-280,30-170,50-150	5.8	335	8.5	2/1

SIENNA

Sienna is a well-balanced, well-built, high-performance reel at an amazingly affordable price. This reel incorporates the Propulsion Line Management system for longer casts and reduced wind knots, and Super Stopper II for instant anti-reverse with no back play. Sienna is perfectly suited for everything from freshwater to inshore fishing.

Model Number	Power Pro Capacity [lb/yd]	Gear Ratio	Weight [g]	Max Drag [kg]	Bearings
500	5/135, 8/105, 10/65	5.6	180	2.0	3/1
1000	10/95, 15/85, 20/65	5.0	185	3.0	3/1
2000	10/140, 15/115, 20/95	5.0	250	4.0	3/1
2500	10-150,15-145,30-100	5.0	250	4.0	3/1
2500HG	10/150, 15/145, 30/100	6.2	250	4.0	3/1
C3000	10/200, 20/140, 40/105	5.0	250	8.5	3/1
4000	15/230, 30/180, 50/120	5.2	320	8.5	3/1

FX

Now with a roller clutch, propulsion spool and an increased bearing count, you'll get more performance features for less with the FX series.

Model Number	Power Pro Capacity [lb/yd]	Gear Ratio	Weight [g]	Max Drag [kg]	Bearings
1000	10/95, 15/85, 20/65	5.0	205	3.0	2/1
2000	10/140, 15/115, 20/95	5.0	250	4.0	2/1
2500	10-150,15-145,30-100	5.0	250	4.0	2/1
2500HG	10/150, 15/145, 30/100	5.0	250	4.0	2/1
C3000	10/200, 20/140, 40/105	5.0	250	8.5	2/1
4000	15/230, 30/180, 50/120	5.2	320	8.5	2/1



8000



2500



2500



2000



SARAGOSA SW NEW

Unmatched Durability.

The Saragosa SW has built an incredible reputation and the new released model takes it to the next level. Packed with upgrades to deliver great cranking power and unmatched durability, no other reel compares at this price point. The Saragosa SWA series features 8 models with the 14000XG and 18000HG being new additions for 2020. The new range incorporates top tier Shimano technologies such as X-Protect, X-Ship, Hagane Body and Hagane gear into its lightweight compact body. The newly designed compact body has been engineered to reduce the weight across the entire series, improving the reels handling and balance. Drawing upon the Stella SWC, Infinity Drive is included and provides improved pinion gear support which translates to greater and smoother cranking power. Built for big fish in extreme conditions, the Saragosa SWA will continue to push the boundaries.

Model Number	PowerPro Capacity [lb/yd]	Gear Ratio	Weight [g]	Max Drag [kg]	Bearings
5000XG	20-245,30-225,40-175	6.2	450	10.0	5/1
6000HG	30-295,50-195,65-140	5.7	455	10.0	5/1
8000HG	40-340,50-265,65-215	5.6	675	16.0	5/1
10000PG	50-360,65-290,80-215	4.9	690	15.0	5/1
14000XG	50-400,65-315,80-240	6.2	700	15.0	5/1
18000HG	50-600,65-440,80-360	5.7	915	22	6/1
20000PG	65-490, 80-400, 100-340	4.4	935	22	6/1
25000	65-630, 80-520, 100-440	4.4	960	20	6/1

SPHEROS SW

The Spheros SW is Shimano's entry level saltwater spinning reel and contains many features found on high end models like X-ship gearing for maximum winding power, hybrid X-Shield body, X-Protect rotor and Super Stopper II. Available in five sizes the versatile 5000, 6000 and 8000 sizes are perfect for casting, spinning and vertical jigging, whilst the larger 10000 and 20000 sizes have increased line capacities and drag ratings making them suitable for big game fish like tuna and GT's. All sizes have AR-C cold forged aluminium spools for excellent casting performance and strength. The Spheros SW is the perfect first time salt water spinning reel or for use as a safety back-up for anglers with more expensive models.

Model Number	Power Pro Capacity [lb/yd]	Gear Ratio	Weight [g]	Max Drag [kg]	Bearings
5000SW	20/255, 30/230, 40/185	4.6	455	10.0	4/1
6000SW	30/245, 50/210, 65/180	4.6	460	10.0	4/1
8000SW	40/300, 50/295, 65/185	4.9	700	12.0	4/1
10000SW	50/405, 65/220, 80/185	4.9	715	12.0	4/1
20000SW	65/525, 80/445, 100/305	4.4	930	18.0	4/1

SOCORRO SW

True durability to tackle nearly anything in the saltwater best describes the Shimano Socorro SW spinning reels. Equipped with long-lasting HAGANE gearing, the Socorro reels give anglers the strength for both inshore and offshore action, and with X-Ship Technology, they offer the ultimate in smoothness and power.

Fish with confidence. Socorro SW reels are ready.

Model Number	Power Pro Capacity [lb/yd]	Gear Ratio	Weight [g]	Max Drag [kg]	Bearings
5000SW	20/245, 30/225, 40/175	4.6	440	10.0	4/1
6000SW	30/290, 50/195, 65/140	4.6	445	10.0	4/1
8000SW	40/340, 50/265, 65/215	4.9	640	12.0	4/1
10000SW	50/360, 65/290, 80/215	4.9	670	12.0	4/1



8000HG



REEL TECHNOLOGY

JDM SPINNING REELS

EXPORT SPINNING REELS

BAITCAST REELS

SW OVERHEAD REELS

ELECTRIC REELS

YUMENA/ GLOSSARY

ROD TECHNOLOGY

SALTWATER RODS

BOAT RODS

BASS RODS

SPECIAL RODS

LIFESTYLE GEAR

MEDIUM BAITRUNNER CI4+ LC 5500 XTB

BIG BAITRUNNER CI4+ LC 14000 XTB

The big and medium Baitrunner Long Cast series is back and they are fitted with some of Shimano's latest technologies. Featuring a long cast AR-C spool design and Aero Wrap II, this combination ensures maximum casting performance from the shoreline. X-Ship ensures the smooth function of the internals and HAGANE Gear provides enduring performance.

Fitted with 4/1 Shielded AR-B bearings and available in a 5500 and 14000 size with a drag output of 15kg and 20kg respectively.

Model Number	Power Pro Capacity [lb/yd]	Gear Ratio	Weight [g]	Max Drag [kg]	Bearings
5500XTB	10-425,12-315,16-230	5.3	510	15.0	4/1
14000XTB	12-600,16-440,20-330	4.6	640	20.0	4/1



14000XTB



BAITRUNNER D

The Baitrunner D series incorporate enough power to take on the biggest of fish. Its proprietary Bait Runner function is both reliable & tough under all situations.

Featuring an XT-7 body and rotor, one piece bail, cold forged Aluminium spool and gear, waterproof drag, shielded A-RB, maintenance port and single Bio-mechanical handle.

Model Number	Power Pro Capacity [lb/yd]	Gear Ratio	Weight [g]	Max Drag [kg]	Bearings
4000D	15/270, 20/190, 40/145	4.8	380	7.0	3/1
6000D	30/245, 50/210, 65/130	4.8	560	9.0	3/1
8000D	40/295, 50/290, 65/180	4.8	610	9.0	3/1
12000D	50/505,65/310, 80/230	4.4	840	12.0	3/1



8000D



BAITRUNNER OC

OC stands for oceanic.

This is the Baitrunner reel at its rawest form. Rugged features like Cold Forged Aluminium Spool, Oversized Power Roller and the legendary Shimano Baitrunner System, this is a reel that is made to overcome a huge range of fishing environments at an affordable price.

Model Number	Power Pro Capacity [lb/yd]	Gear Ratio	Weight [g]	Max Drag [kg]	Bearings
4000OC	15/270, 20/190, 40/145	4.8	380	7.0	3/1
6000OC	30/245, 50/210, 65/130	4.8	545	9.0	3/1
8000OC	40/295, 50/290, 65/180	4.8	590	9.0	3/1
12000OC	50/505,65/310, 80/230	4.4	825	12.0	3/1



8000OC



AERO TECHNIUM MgS 14000XSC/XTC

The Aero Technium MgS is the flagship model of the big pit range. It is a unique reel in the market with only the very best components. The list of features on this reel is huge: every bit of technology Shimano can put in a big pit reel, has been applied to this reel. The light weight of the reel does not mean concessions has been made on the strength or durability of the reel.

HAGANE Body for ultimate protection and rigidity, HAGANE Gear (cold forged) for ultimate gear strength and longevity, X-Protect water/dust protection and a very strong titanium one-piece bail. The Super Slow 10 oscillation system provides the perfect parallel line-lay, which will result in gaining the best casting distance and precision possible. In one sentence: the best big pit reel ever built.

Model Number	Nylon Line Capacity [lb/m]	Gear Ratio	Weight [g]	Max Drag [kg]	Bearings
14000XTC	12-600,16-440,20-330	4.3	485	20.0	8/1
14000XSC	12-600,16-440,20-330	4.3	485	20.0	8/1



ULTEGRA CI4+ XSC/XTC

The use of CI4+ delivers a substantial weight saving on the compact Ultegra body making reel speed easier to generate when distance casting. To further increase casting performance the Ultegra uses Super Slow Oscillation line lay and an AR-C spool fitted with Instant Drag for simple, ultra fast adjustment. Cold Forged gears and X-Ship produce powerful winding performance and 5 Stainless A-RB bearings plus a Shimano Roller bearing deliver supreme smoothness.

Model Number	Nylon Line Capacity [lb/m]	Gear Ratio	Weight [g]	Max Drag [kg]	Bearings
5500XSC	10/425, 12/315, 16/230	5.3	450	15.0	5/1
14000XSC	50/600, 65/390, 80/315	4.3	545	20.0	5/1
5500XTC	10/425, 12/315, 16/230	5.3	455	15.0	5/1
14000XTC	50/600, 65/390, 80/315	4.3	560	20.0	5/1



※ For 14000 only.

ULTEGRA XSD/XTD

The reel is protected according to Shimano's latest innovation X-Protect which will guarantee to protect the reel's inner parts against intrusion of water and dirt. The Parallel Body will help the angler to achieve long and accurate cast without unnecessary fatigue throughout the day.

The Ultegra has a very compact body design which contributes to the feel of a compact and lightweight big pit reel.

Model Number	Nylon Line Capacity [lb/m]	Gear Ratio	Weight [g]	Max Drag [kg]	Bearings
5500XSD	10/425, 12/315, 16/230	5.3	450	15.0	5/1
5500XTD	10/425, 12/315, 16/230	5.3	455	15.0	5/1
14000XSD	12/600, 16/440, 20/330	4.3	645	20.0	4/1
14000XTD	12/600, 16/440, 20/330	4.3	645	20.0	4/1



*For 14000 only.

SpeedMaster 14000 XSC/XTC

SpeedMaster 14000XTC/XSC is a high-performance workhorse reel built for budget-minded surf anglers.

Feature packed with stunning looks, SpeedMaster is equipped with X-Ship technology for improved gear durability and Hi-Speed Drag to put the brakes on big fish. Super Slow Oscillation ensures optimal line lay and maximum casting distance.

Model Number	Nylon Line Capacity [lb/m]	Gear Ratio	Weight [g]	Max Drag [kg]	Bearings
14000XSC	12-600,16-440,20-330	4.3	645	20.0	4/1
14000XTC	12-600,16-440,20-330	4.3	645	20.0	4/1



AERLEX 10000 XSB/XTB

The Aerlex is a tough reel fitted with Instant Drag designed for heavy duty work.

The new cosmetic design and the superb Aero Wrap II line lay with 2 speed Oscillation, combined with the AR-C spool produce the excellent casting performance required by both carp and surf anglers. A high torque 4,6:1 retrieve ratio gives the Aerlex the power to deal with heavy loads over rough ground.

Model Number	Nylon Line Capacity [lb/m]	Gear Ratio	Weight [g]	Max Drag [kg]	Bearings
10000XTB	12/440, 16/330, 20/220	4.6	645	15.0	2/1
10000XSB	12/440, 16/330, 20/220	4.6	645	15.0	2/1



BeastMaster 10000XB

The Beastmaster XB is the renewed version of the Beastmaster XTA/XSA big pit reel.

The 10000 size aluminum spool is more than enough for both anglers who want to fish far out and surf anglers who want to make long casts. The instant drag is smooth and reliable. The reel is painted matte black with grey details: this color is chosen so the reel matches (color wise) with almost every rod in the market and this black colour is appreciated by anglers as well.

Model Number	Nylon Line Capacity [lb/m]	Gear Ratio	Weight [g]	Max Drag [kg]	Bearings
10000XB	40-460,50-360,65-280	4.6	705	15.0	1/1



SPINNING REEL

MAINTENANCE TIPS



1 Tighten drag knob and rinse under low pressure tap water in upright position.



2 Rotate spool and rinse for 15-20 seconds.



3 Use a toothbrush to brush handle area, line roller area and drag knob.



4 Spin reel in fast rotation to channel excess water out.



5 Use a dry cloth to wipe down reel exterior.



6 Use an air duster to spray difficult access area/joints to clear off excess water.



7 Remove drag knob and wipe off excessive water on spool and rotor area.



8 Screw back drag knob and leave it in a cool dry place.

Note:

This is a general guide for reel maintenance. For detailed reel maintenance, please refer to the product instruction manual.

DOS

- ✓ Remove line after deep sea fishing to wash down spool or if intending to keep for long time storage.
- ✓ Avoid placing your reel on boat side rod holders when boat is traveling to prevent splashes of sea water.
- ✓ Put 1-2 drops of oil on main shaft/ line roller/ handle knob bearings/ drive gear bearings and screws after 2-3 times usage.
- ✓ Send for servicing every six months if the reel is being used frequently.

DON'TS

- ✗ Rinsing your reel when drag knob is loose.
- ✗ Remove handle when washing.
- ✗ Using high pressure water to wash down your reel.
- ✗ Wash your reel in an upside down position.
- ✗ Soak reel in a bucket of fresh water.
- ✗ Place your reel under direct sunlight after washing.



ROTATIONAL RESISTANCE IS REDUCED BY ABOUT 60% *, INFINITY DRIVE CHALLENGES THE IMPOSSIBLE

INFINITY DRIVE

Shimano developed a new mechanism to realize a more powerful and light winding. Of the two grease bearings supporting the pinion gear, the bearing on the spool side has a large rotational resistance. Thus we renewed the structure to be supported from the inside of the pinion gear with the spool shaft. In addition, we reviewed each individual part for improvement to eliminate up to about 60% of the rotational resistance, and also achieve high support rigidity. Without lowering the gear strength, the rotation resistance was greatly reduced.



MICROMODULE

NEW DRIVE SYSTEM WITH SUPER MICRO PITCH GEARS

MICROMODULE GEAR

Super micro pitch gears and precise body housing achieve a silky retrieve feeling which you haven't experienced ever before. The retrieve vibration level is reduced by 50%* compared to the previous generation of gears with higher durability due to the increased engagement between gears.

This is an exceptional technology, it can only be Shimano.

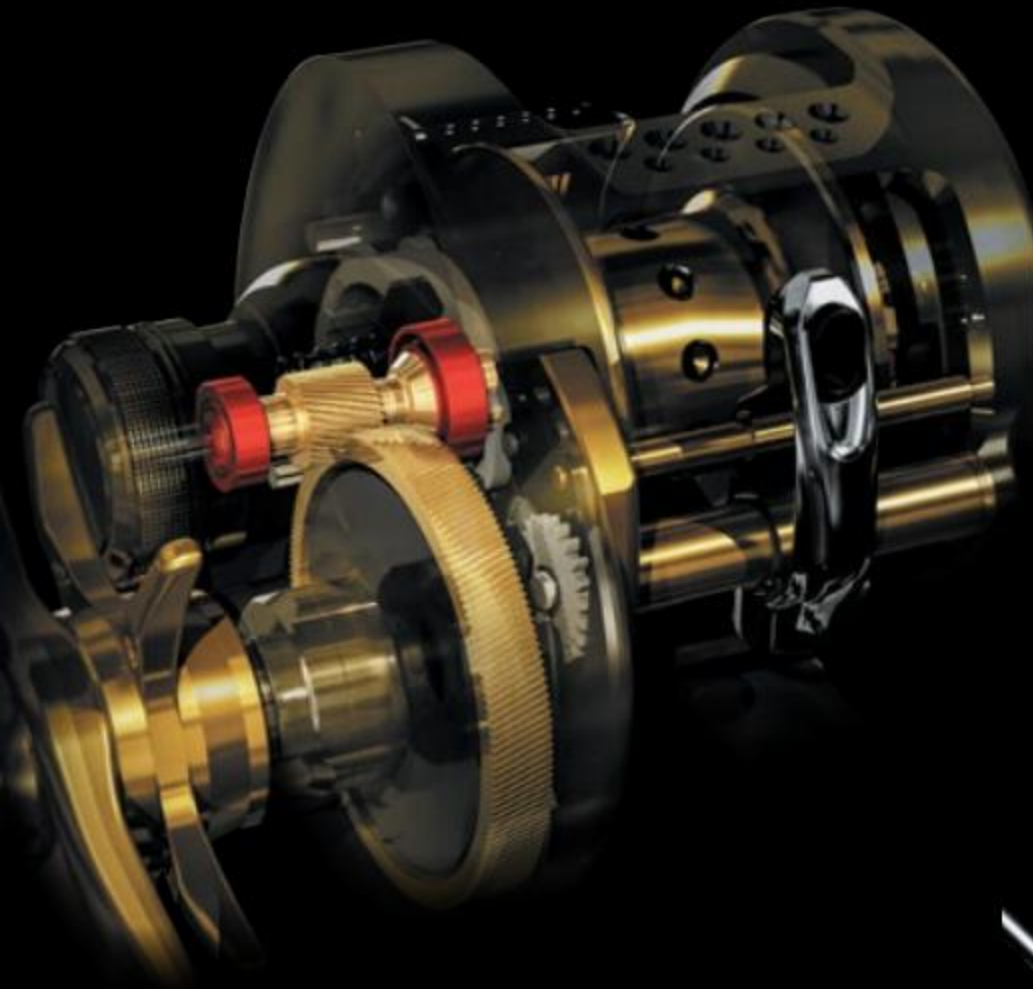

CONTROL THE FALL SPEED WITH EASE AND COMFORT WITH THE LATEST LEVER DESIGN!

FALL LEVER

What used to be difficult to control [fall speed] has become easy and quick to accurately adjust with the latest lever design. Falling fast in the middle columns or slowing down the fall speed near the bottom, more strategies can be devised for your fishing needs. The lever is also designed to be highly operable as the shape helps control of the fall speed to be smooth and tireless.



* Based on internal test by Shimano

I-DC4



The I-DC4 braking system uses an intelligent Digital Control braking system with an easy to use, 4 setting, externally adjustable brake dial. This will allow anglers to fish a wide variety of lures, in any conditions, with minimal adjustment to the reel.



I-DC4 EXSENCE TUNE



With modes 1 to 3 tuned specifically for PE lines and mode 4 for Fluoro lines, this brake system allows for long casting distances for a variety of weights and lures of different weights.



4X8 DC



Having added 8 dial settings to the 4 modes of FL (Fluoro), P (PE), NM (Nylon), X (Extreme Long Cast), making more precise brake adjustments a possibility.



4X8 DC EXSENCE TUNE



The latest braking system for targeting seabass with good long distance casts using PE lines. 8 dial settings have been installed to complement the 4 modes comprising of XP (PE line in the direction of wind), P (PE), N (Nylon) and F (Fluoro).



4X8 DC MD TUNE



In addition to F (Fluoro), P (PE) and NM (Nylon) modes, the fourth mode XB, is specialized for dealing with heavy class lures such as metal jigs and big baits. With the 8 dial settings available, it is possible to achieve just the right amount of brake power needed for large shaped lures which are heavily affected by wind resistance.



I-DC5



A broad selection of 3 internal modes and 5 external dial settings. Using 4 polarized magnet rings, a braking system designed to prevent backlashes has been developed to fruition.



SVS



From a state of complete stop to a full cast, the rotation of the spool is smooth and easy to control with this centrifugal braking system. Toggle between BRAKE ON or BRAKE OFF with just a flick of the brake collars located in the reel.



QUICK CLUTCH

With the same hand that handles the reel and rod, users are able to quickly change between CLUTCH ON and OFF without having to remove their fingers from the spool. It is best suited for ever changing sea beds.



S3D SPOOL

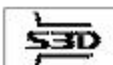

Shimano Stable Spool Design (S3D) features a thin and balanced aluminium wall, resulting in significantly reduced spool vibration and creates an incredibly smooth feeling during casting and retrieving.



COUNTER SPEED DISPLAY

Both fall speed and retrieval speed are shown on the display. At the same time, the depth of the lure is also shown on the display, resulting in a more accurate formulation of strike patterns.



SILENT TUNE



The vibration of the spool is reduced significantly by applying a constant and small amount of pressure on the spool. Smoother spool rotations are more easily kickstarted during casts.

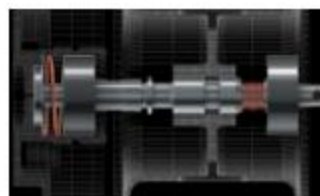

LEVEL WIND LINKAGE

A structure whereby the level wind moves in response to the movement of the spool. This creates a cleared pathway with minimal friction to form a smooth flow of the line, giving better control over the fall action of lures and allowing anglers to be at ease (of line breakage) when fighting against larger fish.



SUPER FREE SPOOL



Only two bearings are used to support the spool after the clutch is disengaged. This eliminates friction on the spool shaft for increased free spool. The result is a longer cast requiring less effort.

STRESS FREE LINE SYSTEM

With the use of narrow spool and tapered level wind, a gentle slope is formed, resulting in smooth line out from the spool and improved smoothness of the drag.

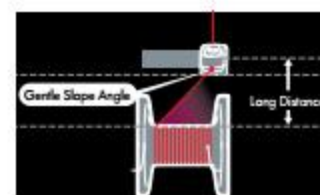

CARBON CROSS WASHER

Thanks to the highly durable material this washer was made from, the effects of high heat on the drag performance is kept to a minimum regardless of low or high load applications.



X-PROTECT



By combining our water repellent coating and our specially designed water channeling, labyrinth construction, X-PROTECT provides high level water resistance without sacrificing light rear and rotor rotation.



X DRAG



By moving the star reel drag knob to the outer side of the handle shaft, the handle is repositioned much closer to the body. This increases both cranking leverage and stability during retrieves



S COMPACT BODY



By making the palming side of the reel smaller than the handle side, palming is made much more comfortable that is almost gives the impression that the reel is actually one size smaller.



ANTARES DC MD

Specifications for great speed and strength made with a tough game in mind.

Utilizing the latest XB brake, cast large lures without stress. Specially catering for a strong fight, including big bait fishing, each part is exclusively tuned to take on large fish. The XB brake can be set at 8 different levels, making it possible to cast lures with high air resistance without stress. With a gear ratio of 7.8 and a maximum drag of 6.0kg, this reel is fit to challenge large fishes.

Model Number	Line Capacity PE [No.-m]	Gear Ratio	Weight [g]	Max Drag [kg]	Bearings
MD XG [R]	3-130, 4-100, 5-80	7.8	235	6.0	10/1
MD XG [L]	3-130, 4-100, 5-80	7.8	235	6.0	10/1

ANTARES DC NEW

An enchanting trajectory of lures flown through the air by our flagship low profile baitcast reel - the Antares.

A condensation of Shimano's latest technologies is the Antares DC, giving you the casting distance you need by incorporating the MGL Spool III onto a DC system (first of its kind!). Coupled with the fine-tune 4x8 DC brake system, a multiplier effect can be seen when it comes to casting far distances.

The S3D spool and Silent Tune eliminates unnecessary vibrations. The Micromodule Gear II, X-Ship and extra bearing on the handle creates a buttery smooth cranking machine in your hands.

Model Number	Nylon Line Capacity [lb/m]	Gear Ratio	Weight [g]	Max Drag [kg]	Bearings
DC [R]	12-130, 14-110, 16-100, 20-80	5.6	220	5.0	11/1
DC [L]	12-130, 14-110, 16-100, 20-80	5.6	220	5.0	11/1
DC HG [R]	12-130, 14-110, 16-100, 20-80	7.4	220	5.0	11/1
DC HG [L]	12-130, 14-110, 16-100, 20-80	7.4	220	5.0	11/1
DC XG [R]	12-130, 14-110, 16-100, 20-80	7.8	225	5.0	11/1
DC XG [L]	12-130, 14-110, 16-100, 20-80	7.8	225	5.0	11/1



XG RIGHT



HG RIGHT



CALCUTTA CONQUEST DC

With the Calcutta Conquest DC, fine adjustments in the brake power of the reel are made possible through the I-DC5 braking system, resulting in a significant improvement in anti-backlash performance. The countermeasures against effects of strong wind on lures are improved with the new W (Wind) mode. With a low inertia to easily kick-start the rotation of the spool, the Magnumlite Spool offers improved castability of the reel, allowing for long and comfortable casts even at low trajectories. Long cast distances are also easily achievable even when using lures which are heavily affected by wind effects. The rigidity of the cold forged body paired with micromodule gear feature gives a low-noise and comfortable cranking experience.

Model Number	Nylon Line Capacity [lb-m]	Gear Ratio	Weight [g]	Max Drag [kg]	Bearings
100 [R]	12-100, 14-90, 16-80	5.6	240	4.0	12/1
101 [L]	12-100, 14-90, 16-80	5.6	240	4.0	12/1
100HG [R]	12-100, 14-90, 16-80	6.8	240	4.0	12/1
101HG [L]	12-100, 14-90, 16-80	6.8	240	4.0	12/1
200 [R]	14-145, 16-120, 20-100	4.8	260	6.0	12/1
201 [L]	14-145, 16-120, 20-100	4.8	260	6.0	12/1
200HG [R]	14-145, 16-120, 20-100	6.2	265	6.0	12/1
201HG [L]	14-145, 16-120, 20-100	6.2	265	6.0	12/1

Metanium DC HG/XG

Metanium DC comes equipped with our new DC brake system called "I-DC5". "I-DC5" has 2 sets of dial adjustment. With the inside dial, you can select the type of line used. (1. Nylon, 2. Fluorocarbon & 3. PE Line) The outside dial adjustment is based on the lure type. 1. Big Lures (18-30g), 2. Medium Lures (10-20g), 3. Small Lures (8-12g) & 4. Finesse Lures (5-8g) There is also the "AUTO" function, letting the on board DC decide optimal brake setting.

Model Number	Nylon Line Capacity [lb-m]	Gear Ratio	Weight [g]	Max Drag [kg]	Bearings
DC [L]	12-120, 14-100, 16-85, 20-70	6.2	190	5.0	9/1
DC [R]	12-120, 14-100, 16-85, 20-70	6.2	190	5.0	9/1
DC HG [L]	12-120, 14-100, 16-85, 20-70	7.4	190	5.0	9/1
DC HG [R]	12-120, 14-100, 16-85, 20-70	7.4	190	5.0	9/1
DC XG [L]	12-120, 14-100, 16-85, 20-70	8.5	195	5.0	9/1
DC XG [R]	12-120, 14-100, 16-85, 20-70	8.5	195	5.0	9/1

EXSENCE DC SS

Bring yourself closer to the realm of Bait Style in the bass game. The essence was developed to do just that! The special settings within the I-DC4 Exsence Tune are easily adjustable and simple to understand. With modes 1 to 3 tuned specifically for PE lines and mode 4 for Fluoro lines, this brake system allows for long casting distances for a variety of weights and lures of different weights. Advanced technologies such as HAGANE body, Micromodule Gear and X-SHIP will help you achieve greater casting distances!

Model Number	Line Capacity PE [No.-m]	Gear Ratio	Weight [g]	Max Drag [kg]	Bearings
HG [R]	1-365, 1.5-255, 2-180	7.4	220	5.0	6/1
HG [L]	1-365, 1.5-255, 2-180	7.4	220	5.0	6/1
XG [R]	1-365, 1.5-255, 2-180	8.5	225	5.0	6/1
XG [L]	1-365, 1.5-255, 2-180	8.5	225	5.0	6/1



100 RIGHT



XG RIGHT



XG RIGHT



REEL TECHNOLOGY
JDM SPINNING REELS
EXPORT SPINNING REELS
BAITCAST REELS
SW OVERHEAD REELS
ELECTRIC REELS
YUMENA/ GLOSSARY
ROD TECHNOLOGY
SALTWATER RODS
BOAT RODS
BASS RODS
SPECIAL RODS
LIFESTYLE GEAR

Scorpion DC NEW

A "free style" reel made for versatility.

Casting long distances? The MGL Spool upgrade has got you covered. Deeper spools mean greater line capacity for various adjustments depending on what you are fishing for. The Micromodule Gear suppresses noise while providing impressionable cranking power. The I-DC5 brake system provides minute changes in brake power which can be adjusted swiftly and tirelessly. The 3 different gear ratios from normal to extra high gears allow for fishing anywhere from bass species to rock fishing!

Model Number	Nylon Line Capacity [lb/m]	Gear Ratio	Weight [g]	Max Drag [kg]	Bearings
150 [R]	12-130, 14-110, 16-100	6.2	215	5.5	7/1
151 [L]	12-130, 14-110, 16-100	6.2	215	5.5	7/1
150HG [R]	12-130, 14-110, 16-100	7.4	215	5.5	7/1
151HG [L]	12-130, 14-110, 16-100	7.4	215	5.5	7/1
150XG [R]	12-130, 14-110, 16-100	8.5	225	5.5	7/1
151XG [L]	12-130, 14-110, 16-100	8.5	225	5.5	7/1



150XG [R]



CURADO DC

Shimano's Curado DC is a reel which features a DC braking system in a lower price class. The I-DC4 braking system will help the angler to cast better and reduces the chance of backlash. The total of 6/1 ball bearings in combination with MicroModule makes the reel run insanely smooth. And due to the combination of a Magnumlite spool + Superfree spool system and the I-DC4 braking system, the angler will even be able to cast and fish also small lures for e.g. bass, perch or toman. The Curado DC might be considered the best reel for crank-bait fishing in this price class. However, since the implementation of X-Ship, the reel is also able to withstand higher forces and can also be used to fish bigger lures.

Model Number	PowerPro Capacity [lb/yd]	Gear Ratio	Weight [g]	Max Drag [kg]	Bearings
150 [R]	20-150,30-135,40-105	6.2	220	5.0	6/1
150HG [R]	20-150,30-135,40-105	7.4	220	5.0	6/1
150XG [R]	20-150,30-135,40-105	8.5	220	5.0	6/1
151 [L]	20-150,30-135,40-105	6.2	220	5.0	6/1
151HG [L]	20-150,30-135,40-105	7.4	220	5.0	6/1
151XG [L]	20-150,30-135,40-105	8.5	220	5.0	6/1



150HG

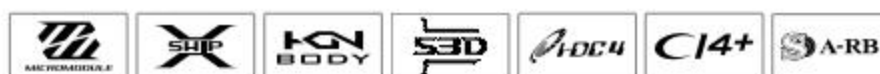

SLX DC

Built on the same compact, rigid and versatile platform as the popular SLX baitcasting reel, the addition of Shimano's unique DC Braking technology has won the SLX DC the title of "Best Freshwater Reel" at the ICAST 2019. SLX DC shows no compromise when it comes to delivering excellent casting performance which is achievable by any angler.

Model Number	PowerPro Capacity [lb-yd]	Gear Ratio	Weight [g]	Max Drag [kg]	Bearings
70 [R]	20-115, 30-105, 40-80	6.3	210	5.5	6/1
71 [L]	20-115, 30-105, 40-80	6.3	210	5.5	6/1
70HG [R]	20-115, 30-105, 40-80	7.2	210	5.5	6/1
71HG [L]	20-115, 30-105, 40-80	7.2	210	5.5	6/1
70XG [R]	20-115, 30-105, 40-80	8.2	210	5.0	6/1
71XG [L]	20-115, 30-105, 40-80	8.2	210	5.0	6/1
150 [R]	20-150, 30-135, 40-105	6.3	215	5.5	4/1
150HG [R]	20-150, 30-135, 40-105	7.2	215	5.0	4/1
150XG [R]	20-150, 30-135, 40-105	8.2	215	5.0	4/1
151 [L]	20-150, 30-135, 40-105	6.3	215	5.5	4/1
151HG [L]	20-150, 30-135, 40-105	7.2	215	5.0	4/1
151XG [L]	20-150, 30-135, 40-105	8.2	215	5.0	4/1



70HG [R]



CALCUTTA CONQUEST BFS

Ever felt undergunned when you fish BFS and hook on a big fish? Fret not! Introducing our first round body bait casting reel for Bait Finesse Fishing! The Calcutta Conquest BFS HG is Shimano's very first round profile BFS reel. It is equipped with Micro Module Gear, X-Ship, HAGANE body and Finesse Tune Brake (FTB) system.

The use of Micro Module Gear and HAGANE Body gives the BFS HG a luxurious retrieval experience. All this smoothness is paired with increased power in cranking. The reel weight is reduced through the adoption of our FTB system which uses a specially designed spool featuring weight-saving holes and magnetic braking.

Model Number	Nylon Line Capacity [lb-m]	Gear Ratio	Weight [g]	Max Drag [kg]	Bearings
BFS HG [R]	8-45	6.8	200	4.0	12/1
BFS HG [L]	8-45	6.8	200	4.0	12/1

ALDEBARAN BFS

Aldebaran BFS is the lightest baitcast reel in the Shimano family. It is designed for pitchy light lures with ease. Its Finesse Tune Brake System (FTB) is the secret behind its superior performance.

Designed for the Finesse Angler, the Aldebaran will never fail its master.

Model Number	Nylon Line Capacity [lb-m]	Gear Ratio	Weight [g]	Max Drag [kg]	Bearings
BFS [R]	8-45	6.5	130	3.5	9/1
BFS [L]	8-45	6.5	130	3.5	9/1
BFS XG [R]	8-45	8.0	130	3.5	9/1
BFS XG [L]	8-45	8.0	130	3.5	9/1

Scorpion BFS

Introducing Scorpion reel with bait finesse specifications.

The Scorpion name is increasing in popularity among many anglers and has expanded its range to include bait finesse specifications. FTB (Finesse Tune Brake) allows you to cast a lure comfortably either by overhead casting or pitching. This reel is suitable for SW use. It can be used for saltwater bait finesse games, a rising trend in the surrounding waters. With Exciting Drag Sound, you will enjoy the thrill of the game.

Model Number	Nylon Line Capacity [lb-m]	Gear Ratio	Weight [g]	Max Drag [kg]	Bearings
BFS [R]	8-45	6.3	165	3.5	7/1
BFS [L]	8-45	6.3	165	3.5	7/1
BFS XG [R]	8-45	8.2	165	3.5	7/1
BFS XG [L]	8-45	8.2	165	3.5	7/1



HG LEFT



XG LEFT



SLX BFS

NEW

A high cost performance entry reel to the bait finesse realm.

The long awaited for bait finesse model enters the impressionable SLX series of baitcasting reels. The SLX BFS uses the Finesse Tune Brake (FTB) system which helps cast even the lightest of lures with finesse and purpose.

Equipped with the X-Ship bearings and exciting drag sound, the SLX BFS is a high quality reel made with a very intent purpose (ultra light game) for you to enjoy.

Model Number	Nylon Line Capacity [lb-m]	Gear Ratio	Weight [g]	Max Drag [kg]	Bearings
RIGHT	8-45	6.3	170	3.5	5/1
LEFT	8-45	6.3	170	3.5	5/1
XG [R]	8-45	8.2	170	3.5	5/1
XG [L]	8-45	8.2	170	3.5	5/1



LEFT



ALDEBARAN MGL

Aldebaran MGL has magnumlite shallow spool which brings lightweight lure fishing to the next level.

This special spool is mounted on Aldebaran dedicated for lightweight lures. Drilled holes on the side of the spool greatly reduces weight and inertia, reducing the braking force required for control. In addition to being able to handle even lighter lures, we also improved the performance of long range casting. Even with the slightest weight will cause instant maximum acceleration the moment you cast.

Model Number	Nylon Line Capacity [lb/m]	Gear Ratio	Weight [g]	Max Drag [kg]	Bearings
30 [R]	8/100, 10/90, 12/65	6.5	135	4.5	9/1
31 [L]	8/100, 10/90, 12/65	6.5	135	4.5	9/1
30HG [R]	8/100, 10/90, 12/65	7.4	135	4.5	9/1
31HG [L]	8/100, 10/90, 12/65	7.4	135	4.5	9/1



30HG RIGHT



BANTAM MGL

40 years after the first Bantam 100, our latest Bantam is reinvented for the present era. By adopting a core solid body integrally molded with level wind protector and side plate, this reel is highly rigid and yet allows vibrations to be transmitted directly to the palm for accurate sensation.

Model Number	Nylon Line Capacity [lb/m]	Gear Ratio	Weight [g]	Max Drag [kg]	Bearings
MGL PG [R]	12/130, 14/110, 16/100	5.5	215	5.0	8/1
MGL PG [L]	12/130, 14/110, 16/100	5.5	215	5.0	8/1
MGL HG [R]	12/130, 14/110, 16/100	7.1	220	5.0	8/1
MGL HG [L]	12/130, 14/110, 16/100	7.1	220	5.0	8/1
MGL [R]	12/130, 14/110, 16/100	6.2	215	5.0	8/1
MGL [L]	12/130, 14/110, 16/100	6.2	215	5.0	8/1
MGL XG [R]	12/130, 14/110, 16/100	8.1	225	5.0	8/1
MGL XG [L]	12/130, 14/110, 16/100	8.1	225	5.0	8/1



RIGHT



Scorpion MGL

The Scorpion MGL exhibits excellent castability with the highly responsive MGL Spool. With the rigidity from its HAGANE body and the smoothness of the Micromodule gears, this reel is both smooth and powerful.

Model Number	Nylon Line Capacity [lb/yd]	Gear Ratio	Weight [g]	Max Drag [kg]	Bearings
150 (R)	12/130, 14/110, 16/100	6.2	210	5.5	7/1
151 (L)	12/130, 14/110, 16/100	6.2	210	5.5	7/1
150HG (R)	12/130, 14/110, 16/100	7.4	210	5.5	7/1
151HG (L)	12/130, 14/110, 16/100	7.4	210	5.5	7/1
150XG (R)	12/130, 14/110, 16/100	8.5	215	5.5	7/1
151XG (L)	12/130, 14/110, 16/100	8.5	215	5.5	7/1



150XG RIGHT



CURADO MGL

NEW

Dependability and Performance.

Small in hand but large in durability, dependability and performance, the Curado MGL 70 K is a new addition to Shimano's coveted line of Curado low-profile reels. The reel's lightweight MGL Spool requires less start-up energy due to decreased inertia and results in longer casts with reduced effort.

The new Curado MGL 70 K is a great reel choice for anglers pitching and flipping in tight cover when increased line capacity is not required. But anglers shouldn't be concerned about its compact size when fighting fish in close quarters or heavy cover, it is equipped with a Cross Carbon Drag to provide the needed stopping power against large fish. And just like the rest of the Curado family of reels, the versatile Curado MGL 70 K features MicroModule Gear for enhanced smoothness as well as a HAGANE Body for increased rigidity and durability for years of fishing performance.

Model Number	PowerPro Line Capacity [lb/yds]	Gear Ratio	Weight [g]	Max Drag [kg]	Bearings
70HG [R]	20-115,30-105,40-80	7.4	195	5.5	8/1
71HG [L]	20-115,30-105,40-80	7.4	195	5.5	8/1
70XG [R]	20-115,30-105,40-80	8.1	195	5.5	8/1
71XG [L]	20-115,30-105,40-80	8.1	195	5.5	8/1



70HG [R]



SLX MGL

A responsive MGL Spool in a HAGANE body has given birth to the SLX MGL reel with incredibly high castability and outstanding rigidity. The highly performing SLX is clad with specs from high end models.

Model Number	Nylon Line Capacity [lb/m]	Gear Ratio	Weight [g]	Max Drag [kg]	Bearings
70 [R]	12/100, 14/90, 16/80	6.3	190	5.5	4/1
71 [L]	12/100, 14/90, 16/80	6.3	190	5.5	4/1
70HG [R]	12/100, 14/90, 16/80	7.2	195	5.5	4/1
71HG [L]	12/100, 14/90, 16/80	7.2	195	5.5	4/1
70XG [R]	12/100, 14/90, 16/80	8.2	195	5.5	4/1
71XG [L]	12/100, 14/90, 16/80	8.2	195	5.5	4/1



70 RIGHT



REEL TECHNOLOGY
JDM SPINNING REELS
EXPORT SPINNING REELS
BAITCAST REELS
SW OVERHEAD REELS
ELECTRIC REELS
YUMEVU/ GLOSSARY
ROD TECHNOLOGY
SALTWATER RODS
BOAT RODS
BASS RODS
SPECIAL RODS
LIFESTYLE GEAR

ANTARES

Silent Spool and S3D Spool, these are the two features on the Antares which eliminates as much as possible the vibration which come with a rotating spool.

Displaying one of the finest responses in a reel with the latest MGL Spool III, technical casts such as pitching and skipping are executed perfectly.

Model Number	Nylon Line Capacity [lb/m]	Gear Ratio	Weight [g]	Max Drag [kg]	Bearings
RIGHT	12/100, 14/90, 16/80, 20/65	6.2	220	5.0	10/1
LEFT	12/100, 14/90, 16/80, 20/65	6.2	220	5.0	10/1
HG RIGHT	12/100, 14/90, 16/80, 20/65	7.4	220	5.0	10/1
HG LEFT	12/100, 14/90, 16/80, 20/65	7.4	220	5.0	10/1

Metanium

A core solid body combined with a low moment of inertia Magnumlite Spool III.

Strong yet light, bring this reel on you to a myriad of fishing scenes and still be confident that you have a trusty and versatile partner on hand. Being a lightweight and highly operable reel, the revamped Metanium is an all rounder with its Magnesium core solid body. Cast lighter lures to greater distances with the Magnumlite Spool III on every reel in the lineup. Easy to use and with improved adaptability, the lineup brings technicality into the game including light rigs. The toughness does not only lie in the body of the reel, but the drive gear is also powerful enough to win you those tough fights on the water.

Model Number	Nylon Line Capacity [lb/m]	Gear Ratio	Weight [g]	Max Drag [kg]	Bearings
RIGHT	12/100, 14/90, 16/80, 20/65	6.2	175	5.0	10/1
LEFT	12/100, 14/90, 16/80, 20/65	6.2	175	5.0	10/1
HG [R]	12/100, 14/90, 16/80, 20/65	7.1	175	5.0	10/1
HG [L]	12/100, 14/90, 16/80, 20/65	7.1	175	5.0	10/1
XG [R]	12/100, 14/90, 16/80, 20/65	8.1	175	5.0	10/1
XG [L]	12/100, 14/90, 16/80, 20/65	8.1	175	5.0	10/1

CALCUTTA CONQUEST

NEW

Overbearing power with Shimano's flagship round profile baitcast reel.

The Calcutta Conquest's highly rigid metal body gives a solid cranking feel. It is the first time the highly regarded Infinity Drive (previously only on SW reels) has been included in a baitcast model.

Upgrade includes more powerful hoisting capabilities with lighter and smoother cranking feel. Palming is also made more comfortable by applying low profiling on the body.

Model Number	Nylon Line Capacity [lb/m]	Gear Ratio	Weight [g]	Max Drag [kg]	Bearings
100 [R]	12-100, 14-90, 16-80, 20-65	5.6	220	4.5	13/1
101 [L]	12-100, 14-90, 16-80, 20-65	5.6	220	4.5	13/1
100HG [R]	12-100, 14-90, 16-80, 20-65	7.4	220	4.0	13/1
101HG [L]	12-100, 14-90, 16-80, 20-65	7.4	220	4.0	13/1
200 [R]	12-165, 14-145, 16-120, 20-100	4.8	235	6.0	13/1
201 [L]	12-165, 14-145, 16-120, 20-100	4.8	235	6.0	13/1
200HG [R]	12-165, 14-145, 16-120, 20-100	6.5	240	6.0	13/1
201HG [L]	12-165, 14-145, 16-120, 20-100	6.5	240	6.0	13/1
300 [R]	16/210, 20/160, 25/135	6.2	330	7.0	12/1
301 [L]	16/210, 20/160, 25/135	6.2	330	7.0	12/1
400 [R]	16/300, 20/235, 25/200	6.2	340	7.0	12/1
401 [L]	16/300, 20/235, 25/200	6.2	340	7.0	12/1



RIGHT



HG RIGHT



100HG [R]



Scorpion

With extended line capacity and improved durability, it's hard to resist the Scorpion. Featuring X-Ship and sturdy aluminium frame, the Scorpion is made to tackle any fishing conditions. The SVS brake system is designed to be lightweight, contributing to low inertia startup during casting. Also available in sizes 70 now.

Model Number	Nylon Line Capacity [lb/m]	Gear Ratio	Weight [g]	Max Drag [kg]	Bearings
70 [R]	12/100, 14/90, 16/80	6.3	190	4.5	7/1
70HG [R]	12/100, 14/90, 16/80	7.2	190	4.5	7/1
70XG [R]	12/100, 14/90, 16/80	8.2	190	4.5	7/1
71 [L]	12/100, 14/90, 16/80	6.3	190	4.5	7/1
71HG [L]	12/100, 14/90, 16/80	7.2	190	4.5	7/1
71XG [L]	12/100, 14/90, 16/80	8.2	190	4.5	7/1



70HG RIGHT



CURADO K NEW

Reliability and Durability.

The K series of Curado baitcast reels re-define saltwater durability. To withstand the saltwater environment, they feature a specially plated pinion gear, combined with a breakwater wall and drainage port to provide superior protection from water intrusion and corrosion. The durable Hagane Body houses Shimano's innovative MicroModule gearing, it has X-Ship for smooth rotation, and the SVS Infinity Braking System for enhanced casting performance.

Now available in size 200PG, 201PG, 300HG, and 301HG!

Model Number	PowerPro Line Capacity [lb-yd]	Gear Ratio	Weight [g]	Max Drag [kg]	Bearings
200 [R]	8-180, 10-155, 14-110	6.2	215	5.0	6/1
201 [L]	8-180, 10-155, 14-110	7.4	215	5.0	6/1
200HG [R]	8-180, 10-155, 14-110	8.5	220	5.0	6/1
201HG[L]	8-180, 10-155, 14-110	6.2	215	5.0	6/1
200XG [R]	8-180, 10-155, 14-110	7.4	215	5.0	6/1
201XG [L]	8-180, 10-155, 14-110	8.5	220	5.0	6/1
200PG [R]	30-190,50-120,65-80	5.0	220	5.5	6/1
201PG [L]	30-190,50-120,65-80	5.0	220	5.5	6/1
300 [R]	40-195, 50-190, 65-125	4.7	295	8.0	5/1
301 [L]	40-195, 50-190, 65-125	4.7	295	8.0	5/1
300HG [R]	40-195, 50-190, 65-125	6.6	295	10.0	5/1
301HG [L]	40-195, 50-190, 65-125	6.6	295	10.0	5/1



SLX XT

The new SLX XT offers enhanced casting performance with the New SVS Infinity braking system for anglers targeting Peacock Bass and Barramundi. The aluminium Hagane body ensures that the reel is extremely rigid and durable. The main upgrade for the SLX XT comes in the form of the New SVS Infinity breaking system. Anglers will have much greater control using the external dial to adjust the braking system with ease, which allows them cast a wider range of lure styles and weights in varying fishing conditions.

Model Number	Power Pro Capacity [lb-m]	Gear Ratio	Weight [g]	Max Drag [kg]	Bearings
150 [R]	20-150,30-135,40-105	6.3	205	5.5	4/1
150HG [R]	20-150,30-135,40-105	7.2	205	5.0	4/1
150XG [R]	20-150,30-135,40-105	8.2	205	5.0	4/1
151 [L]	20-150,30-135,40-105	6.3	205	5.5	4/1
151HG [L]	20-150,30-135,40-105	7.2	205	5.0	4/1
151XG [L]	20-150,30-135,40-105	8.2	205	5.0	4/1



150HG



REEL TECHNOLOGY
JDM SPINNING REELS
EXPORT SPINNING REELS
BAITCAST REELS
SW OVERHEAD REELS
ELECTRIC REELS
YUMENA/ GLOSSARY
ROD TECHNOLOGY
SALTWATER RODS
BOAT RODS
BASS RODS
SPECIAL RODS
LIFESTYLE GEAR

SLX

The Shimano SLX is the replacement model for the Caenan. With a significant smaller body (22%), the SLX has a very ergonomic shape and is perfect for palming the reel in your hand, making it very comfortable to fish with whole day long. This Mid-Entry price level reel is a perfect all-round reel which can be used for all kinds of fishing and would be great for an angler first baitcasting reel experience.

Model Number	Power Pro Capacity [lb/m]	Gear Ratio	Weight [g]	Max Drag [kg]	Bearings
150 [R]	20-150,30-135,40-105	6.3	195	5.5	3/1
150HG [R]	20-150,30-135,40-105	7.2	195	5.0	3/1
150XG [R]	20-150,30-135,40-105	8.2	195	5.0	3/1
151 [L]	20-150,30-135,40-105	6.3	195	5.5	3/1
151HG [L]	20-150,30-135,40-105	7.2	195	5.0	3/1
151XG [L]	20-150,30-135,40-105	8.2	195	5.0	3/1



150HG



BASS ONE XT

Entry model doesn't have to be basic; our entry baitcast reel just got updated! We've incorporated the SVS brake system with the BassOne XT giving anglers control over brake settings to the minute level. Line capacity has also been reduced in line with current fishing trends, 200 model is now 150 model. A value for money model highly recommended to any angler!

Model Number	Nylon Line Capacity [lb/m]	Gear Ratio	Weight [g]	Max Drag [kg]	Bearings
150XT [R]	12/130, 14/110, 16/100	7.2	210	5.0	4/1
151XT [L]	12/130, 14/110, 16/100	7.2	210	5.0	4/1



RIGHT



GENPU XT

Genpu XT is specifically developed for a wide variety of light offshore vertical techniques. The 200PG/201PG model features a 60mm power handle equipped with a CI4+ extra-large handle knob, which ensures a solid grip and comfortable reeling from the deep. Although it is a very compact and easy to palm reel, it has a line capacity of 200m of PE2, which allows to fish at considerable depths.

Model Number	Line Capacity PE [no./m]	Gear Ratio	Weight [g]	Max Drag [kg]	Bearings
150[R]	1.5-200, 2-150, 3-100	6.3	195	4.5	3/1
151[L]	1.5-200, 2-150, 3-100	6.3	195	4.5	3/1
200PG [R]	1.5-260, 2-200, 3-130	5.5	195	5.0	3/1
201PG [L]	1.5-260, 2-200, 3-130	5.5	195	5.0	3/1



200PG [R]



CAIUS

The Caius is a compact, versatile, and durable baitcasting reel, designed with lightweight lure casting in mind. The Super Free Spool improves casting performance and the improved 6-pin VBS (Variable Braking System) keeps backlash to a minimum with all weights and sizes of lures.

Model Number	Power Pro Line Capacity [lb/m]	Gear Ratio	Weight [g]	Max Drag [kg]	Bearings
150HG [R]	20-150,30-135,40-105	7.2	195	5.0	3/1
151HG [L]	20-150,30-135,40-105	7.2	195	5.0	3/1



150HG



Scorpion MD NEW

A combination of both power and precision results in an ultra long lasting reel.

Fit for those who have set eyes on fighting against river monsters with a line stock of up to 160m of 20 lb nylon line on the spool. The spool has been lightened and narrowed to give more stability during line outlay. The SVS brake system has been upgraded from using 6 pins to the current 8 pins on the brake wheel to provide you with even finer adjustments in brake power for optimal casting distances and anti-backlash purposes.

Model Number	Nylon Line Capacity [lb-m]	Gear Ratio	Weight [g]	Max Drag [kg]	Bearings
300XG [R]	16-210, 20-160, 25-135	7.9	320	8.0	7/1
301XG [L]	16-210, 20-160, 25-135	7.9	320	8.0	7/1
300XGLH [R]	16-210, 20-160, 25-135	7.9	315	8.0	7/1
301XGLH [L]	16-210, 20-160, 25-135	7.9	315	8.0	7/1

GRAPPLER NEW

150HG/151HG

A light jigging reel with a fall lever to expand your fishing horizons.

The Grappler has what it needs to perform mesmerizing fall actions - the Fall Lever & the Level Wind Synchronization. With the standard 78 cm retrieve per crank, mix in different pitch while jigging according to your needs. Whether it is bottom fishing, jigging or in-shore fishing, this reel covers a broad spectrum of the fishing game.

Model Number	PE Line Capacity [no-m]	Gear Ratio	Weight [g]	Max Drag [kg]	Bearings
150HG [R]	0.8-400, 1-330, 1.5-200	7.8	205	4.0	8/1
151HG [L]	0.8-400, 1-330, 1.5-200	7.8	205	4.0	8/1

GRAPPLER

This series has just been improved with the use of advanced technologies by Shimano. In addition to the HAGANE body, the Grappler has a X-ship structure and Micromodule gears calling for a more stable and smooth cranking experience even under high loads. Moreover, the 70mm round knob is made of the C14+ material, making it strong yet light. With a line capacity of 250m of PE 3.0 line and a gear ratio of 6.2, this reel is not limited to light jigging and jigging. Slow jigging has also been made possible with the Grappler.

Model Number	Line Capacity PE [No./m]	Gear Ratio	Weight [g]	Max Drag [kg]	Bearings
300HG [R]	2/380, 3/250, 4/190	6.2	325	7.0	5/1
301HG [L]	2/380, 3/250, 4/190	6.2	325	7.0	5/1

BAY GAME

The rigidity stems from the reels' HAGANE bodies. The smooth reeling experience, from the X-ship structure and Micromodule Gear feature, allowing for accurate distinction between a real bite and a miss. With the advanced centrifugal brakes, feel each cast as the SVS infinity brake system brings your lures soaring through the sky. Using a PE2.0 line rating, the spool is capped at 380m of the line and a handle length of 70mm, the latest additions to the Baygame are powerful models with a maximum drag of 8kg. Superb for deep sea fishing and targeting larger species!

Model Number	Line Capacity PE [No./m]	Gear Ratio	Weight [g]	Max Drag [kg]	Bearings
150 [R]	1.5/200, 2/150, 3/100	6.9	220	5.0	4/1
151 [L]	1.5/200, 2/150, 3/100	6.9	220	5.0	4/1
150DH [R]	1.5/200, 2/150, 3/100	6.9	220	5.0	4/1
151DH [L]	1.5/200, 2/150, 3/100	6.9	220	5.0	4/1
300PG [R]	2/380, 3/250, 4/190	4.8	325	8.0	5/1
301 [L]	2/380, 3/250, 4/190	4.8	325	8.0	5/1



300XG RIGHT



150HG [R]



300HG [R]



300PG RIGHT



※1 : 300PG • 301PG
 ※2 : 150 • 151 • 150DH • 151DH

REEL TECHNOLOGY
 JDM SPINNING REELS
 EXPORT SPINNING REELS
 BAITCAST REELS
 SW OVERHEAD REELS
 ELECTRIC REELS
 YUMENA/ GLOSSARY
 ROD TECHNOLOGY
 SALTWATER RODS
 BOAT RODS
 BASS RODS
 SPECIAL RODS
 LIFESTYLE GEAR

TRANX

Whether you are throwing large minnows at mackerels or big rubber frogs into heavy cover for snakehead, this reel can do it all! This is our penultimate large size baitcaster designed for fishing the toughest environment. The Tranx encompasses all our best baitcast technology including Hagane body with Aluminium side plate, X-ship gears.

Model Number	Line Capacity PE [No./m]	Gear Ratio	Weight [g]	Max Drag [kg]	Bearings
200A [R]	30/190, 50/120, 65/80	6.2	240	13.0	3/1
200AHG [R]	30/190, 50/120, 65/80	7.2	240	13.0	3/1
200AXG [R]	30/190, 50/120, 65/80	8.5	240	13.0	3/1
201AHG [L]	30/190, 50/120, 65/80	7.2	240	12.0	3/1
300A [R]	12/230, 14/180, 17/150	5.8	330	10.0	5/1
301A [L]	12/230, 14/180, 17/150	5.8	330	10.0	5/1
300AHG [R]	12/230, 14/180, 17/150	7.6	330	8.0	5/1
301AHG [L]	12/230, 14/180, 17/150	7.6	330	8.0	5/1
400A [R]	12/330, 14/260, 20/160	5.8	340	10.0	5/1
401A [L]	12/330, 14/260, 20/160	5.8	340	10.0	5/1
400AHG [R]	12/330, 14/260, 20/160	7.6	340	8.0	5/1
401AHG [L]	12/330, 14/260, 20/160	7.6	340	8.0	5/1

OCEA JIGGER F CUSTOM

Finally, the fall lever has found its way onto the Ocea Jigger! With the latest shape of the fall lever, anglers can now control the lever with higher precision. Fall action of jigs can be controlled more easily without having to monitor the fall speed, allowing anglers to focus on detecting bites underwater. The handle knob has also been re-designed to be lighter and give a better grip to anglers so as to facilitate mid-deep games. We recommend sizes 1000 and 1500 for mid-deep games and sizes 2000 and 3000 for large games.

Model Number	Line Capacity PE [No./m]	Gear Ratio	Weight [g]	Max Drag [kg]	Bearings
1000HG [R]	2/300, 2.5/230, 3/200	6.4	430	7.0	8/1
1001HG [L]	2/300, 2.5/230, 3/200	6.4	430	7.0	8/1
1500HG [R]	2/300, 2.5/400, 3/320	6.4	430	7.0	8/1
1501HG [L]	2/300, 2.5/400, 3/320	6.4	430	7.0	8/1
2000NRHG [R]	3/400, 4/300, 5/220	6.2	605	10.0	8/1
2001NRHG [L]	3/400, 4/300, 5/220	6.2	605	10.0	8/1
3000HG [R]	3/670, 4/480, 5/400, 6/330	6.2	630	10.0	8/1

OCEA JIGGER

"How do you improve a legend?" We start from deep within. Fusing our most advanced manufacturing capabilities with the wants of anglers. The Ocea Jigger's cranking action is lighter and smoother than before. With the use of MicroModule gears, cold forged long crank handle and Infinity Drive, we achieved a reel that is strong, faster and smoother by 60%! A shape star drag, carbon cloth washer and a larger brake knob are some of the other updates to a well-loved classic among the fishing community.

Model Number	Line Capacity PE [No./m]	Gear Ratio	Weight [g]	Max Drag [kg]	Bearings
1000HG [R]	2/300, 2.5/230, 3/200	6.4	405	7.0	8/1
1001HG [L]	2/300, 2.5/230, 3/200	6.4	405	7.0	8/1
1500HG [R]	2/500, 2.5/400, 3/320	6.4	405	7.0	8/1
1501HG [L]	2/500, 2.5/400, 3/320	6.4	405	7.0	8/1
1500PG [R]	2/500, 2.5/400, 3/320	5.1	405	7.5	8/1
1501PG [L]	2/500, 2.5/400, 3/320	5.1	405	7.5	8/1
2000NRPG [R]	3/400, 4/300, 5/220	5.1	595	10.0	8/1
2001NRPG [L]	3/400, 4/300, 5/220	5.1	595	10.0	8/1
2000NRHG [R]	3/400, 4/300, 5/220	6.2	595	10.0	8/1
2001NRHG [L]	3/400, 4/300, 5/220	6.2	595	10.0	8/1



400AHG



2000NRHG [R]



1500HG [R]



OCEA JIGGER 4000/4000HG

An overhead reel for jigging, bring the latest addition to the OCEA JIGGER series - the size 4000, on your deep sea and off-island expeditions. In addition to being able to hold up to 1200m long of a PE 3.0 rated line, the outer diameter of the palming side of the reel has been made smaller and this makes the reel much more comfortable to hold. The 4000 size retains the solid construction and winding/cranking performance of the JIGGER series. The drag force can be more precisely adjusted with the large star drag on the reel.

Model Number	Line Capacity PE [No./m]	Gear Ratio	Weight [g]	Max Drag [kg]	Bearings
4000 [R]	3-1200, 4-900, 5-700, 6-580	4.4	785	18	6/1
4000HG [R]	3-1200, 4-900, 5-700, 6-580	5.1	790	18	6/1



4000HG [R]



OCEA CONQUEST CT

The Ocea Conquest CT is the addition of a digital counter and a fall lever onto the Ocea Conquest. Know exactly the depth of the target zone with the digital counter. Control perfectly the fall action of jigs with the fall lever. Applying the knowledge of science, this reel is definitely one of the top few options for committed anglers looking for the best partner.

Model Number	Line Capacity PE [No./m]	Gear Ratio	Weight [g]	Max Drag [kg]	Bearings
200HG [R]	1/440, 2/200	6.2	340	5.0	10/1
201HG [L]	1/440, 2/200	6.2	340	5.0	10/1
200PG [R]	1/440, 2/200	4.8	330	6.0	12/1
201PG [L]	1/440, 2/200	4.8	330	6.0	12/1
300HG [R]	2/380, 3/240, 4/170	6.2	390	7.0	10/1
301HG [L]	2/380, 3/240, 4/170	6.2	390	7.0	10/1
300PG [R]	2/380, 3/240, 4/170	4.8	390	8.0	10/1
301PG [L]	2/380, 3/240, 4/170	4.8	390	8.0	10/1



300PG [R]



OCEA CONQUEST LIMITED NEW

In addition to the strong, smooth and highly operable offshore reel which is the OCEA Conquest is the latest OCEA Conquest Limited, now with a fall lever. Regardless of light game or assertive fishing styles, this reel covers it all. With the fall lever made available, anglers now have access to an even wider variety of jig actions at their fingertips. Adding to the aesthetically appealing dark blue body is the cold forged Aluminium handle which is lighter and more durable!

Model Number	Line Capacity PE [no./m]	Gear Ratio	Weight [g]	Max Drag [kg]	Bearings
200HG [R]	1-440,2-200	6.2	300	5.0	10/1
201HG [L]	1-440,2-200	6.2	300	5.0	10/1
200PG [R]	1-440,2-200	4.8	290	6.0	12/1
201PG [L]	1-440,2-200	4.8	290	6.0	12/1
300HG [R]	2/380, 3/240, 4/170	6.2	365	7.0	10/1
301HG [L]	2/380, 3/240, 4/170	6.2	365	7.0	10/1
300PG [R]	2/380, 3/240, 4/170	4.8	360	8.0	10/1
301PG [L]	2/380, 3/240, 4/170	4.8	360	8.0	10/1
400HG [R]	2/500, 3/320, 4/250	6.2	375	7.0	10/1



200HG [R]



REEL TECHNOLOGY

JIG SPINNING REELS

EXPORT SPINNING REELS

BAITCAST REELS

SW OVERHEAD REELS

ELECTRIC REELS

YUMENVA/ GLOSSARY

ROD TECHNOLOGY

SALTWATER RODS

BOAT RODS

BASS RODS

SPECIAL RODS

LIFESTYLE GEAR

OCEA CONQUEST

This reel produces revolutionary new cranking smoothness for the angler. Equipped with Micromodule gears, the cranking is butter smooth. Finer gearing also means more minute movement can be detected for the perfect lure presentation. S Compact Body for the reel reduces body size and improves the ergonomics of the reel.

Model Number	Line Capacity PE [No.-m]	Gear Ratio	Weight [g]	Max Drag [kg]	Bearings
200PG [R]	1-440, 2-200	4.8	275	6.0	12/1
201PG [L]	1-440, 2-200	4.8	275	6.0	12/1
200HG [R]	1-440, 2-200	6.2	285	5.0	10/1
201HG [L]	1-440, 2-200	6.2	285	5.0	10/1
300PG [R]	2-380, 3-240, 4-170	4.8	340	8.0	10/1
301PG [L]	2-380, 3-240, 4-170	4.8	340	8.0	10/1
300HG [R]	2-380, 3-240, 4-170	6.2	345	7.0	10/1
301HG [L]	2-380, 3-240, 4-170	6.2	345	7.0	10/1



300PG [R]



TORIUM

The latest TORIUM models are entry models focused more on cost performance. The reels in this line adopts the rigid HAGANE body and is very comfortable in the hands with the S-COMPACT body. Feel at ease while jigging with the spool lock and handle return structure on the reels. Consisting of 3 reels, this lineup covers a wide range of situations and will make your fishing trips worth their while.

Model Number	Line Capacity PE [No./m]	Gear Ratio	Weight [g]	Max Drag [kg]	Bearings
1500HG	2/500, 2.5/400, 3/320	6.3	435	7	3/1
2000HG	3/400, 4/300, 5/220	6.2	555	11	3/1
2000PG	3/400, 4/300, 5/220	4.6	550	15	3/1



1500HG



TORIUM

Packed with features like Super Stopper, Cross Carbon Drag, A-RB(Anti-Rust Bearings) and High Efficiency Gearing (HEG), the Torium has it where it counts.

Model Number	PowerPro Line Capacity [lb/yd]	Gear Ratio	Weight [g]	Max Drag [kg]	Bearings
14HGA [R]	14/300, 16/270, 20/200	6.3	425	15.0	3/1
16HGA [R]	50/530, 65/330, 80/250	6.2	535	11.0	3/1
20HGA [R]	50/710, 65/375, 80/310	6.2	545	11.0	3/1
30HGA [R]	50/1015, 65/515, 80/415	6.2	560	11.0	3/1
16HGA [L]	50/530, 65/330, 80/250	6.2	535	11.0	3/1
20HGA [L]	50/710, 65/375, 80/310	6.2	545	11.0	3/1
30HGA [L]	50/1015, 65/515, 80/415	6.2	560	11.0	3/1



30HGA



14HGA



TEKOTA

The Tekota is a small sized SW boat fishing and/or light trolling reel. It describes itself best as 'a workhorse'. The reel has a level wind system which is easy for the angler to get the line spooled well on the spool.

Model Number	PowerPro Line Capacity [lb/yd]	Gear Ratio	Weight [g]	Max Drag [kg]	Bearings
300HGLC [R]	30-290, 40-230, 50-190	6.6	340	9.0	3/1
301HGLC [L]	30-290, 40-230, 50-190	6.6	340	9.0	3/1
400HGLC [R]	40-320, 50-270, 65-195	6.6	385	9.0	3/1
401HGLC [L]	40-320, 50-270, 65-195	6.6	385	9.0	3/1
500HG [R]	40-390, 50-330, 65-240	6.3	440	11.0	3/1
600HG [R]	40-540, 50-460, 65-330	6.3	465	11.0	3/1
501HG [L]	40-390, 50-330, 65-240	6.3	440	11.0	3/1
601HG [L]	40-540, 50-460, 65-330	6.3	465	11.0	3/1
500HGLC [R]	40-390, 50-330, 65-240	6.3	465	11.0	3/1
600HGLC [R]	40-540, 50-460, 65-330	6.3	485	11.0	3/1
501HGLC [L]	40-390, 50-330, 65-240	6.3	465	11.0	3/1
601HGLC [L]	40-540, 50-460, 65-330	6.3	485	11.0	3/1
500HGLCM [R]	40-390, 50-330, 65-240	6.3	465	11.0	3/1
600HGLCM [R]	40-540, 50-460, 65-330	6.3	485	11.0	3/1



400HGLC



SpeedMaster LD II

With a high maximum drag power and a smooth, ultra-wide range of drag adjustability is the SpeedMaster II. Its rigid HAGANE Body prevents misalignment of moving parts under the heaviest loads. Plus, a spare drag cam is included for optimal use with mono-filament lines.

Model Number	PowerPro Line Capacity [lb/yd]	Gear Ratio	Weight [g]	Max Drag [kg]	Bearings
12 II	50/700	5.7/3.1	740	18.0	4/0
16 II	50/845	5.7/3.1	760	18.0	4/0
20 II	66/725	5.2/2.3	980	20.0	4/0
25 II	65/900	5.2/2.3	1025	20.0	4/0

TALICA

Based upon a narrow body principle which equals less weight, smaller dimensions and easier handling than equivalent lever drag multipliers, Talica is truly a high-speed dream machine.

Model Number	PowerPro Line Capacity [lb/yd]	Gear Ratio	Weight [g]	Max Drag [kg]	Bearings
8 II	40/395, 50/390, 65/235	6.2/4.1	970	7.0	6/0
10 II	40/540, 50/534, 65/335	6.2/4.1	1060	9.0	6/0
12 II	50/700, 65/400, 80/355	6.2/4.1	1410	9.0	6/0
16 II	50/845, 65/485, 80/430	6.2/4.1	1485	12.0	6/0
20 II	65/725, 80/575, 100/435	5.2/2.3	920	20.0	6/0
25 II	65/1000, 80/730, 100/470	5.2/2.3	950	20.0	6/0
50 II	80/1120, 100/945, 150/825	6.2/4.1	1570	27.0	6/0
8	40/395, 50/390, 65/235	6.2	451	7.0	6/0
10	40/540, 50/534, 65/335	6.2	465	9.0	6/0
12	50/700, 65/400, 80/355	5.7	669	9.0	6/0
16	50/845, 65/485, 80/430	5.7	669	12.0	6/0

TIAGRA

The big game reel that became a worldwide market leader has too many features to explain in a catalogue! It's the solid construction, in combination with easy to use features, that is loved by the most demanding big game fishermen.

Model Number	PowerPro Line Capacity [lb/yd]	Gear Ratio	Weight [g]	Max Drag [kg]	Bearings
12	40/795, 50/790, 65/460	3.9/1.7	970	15.0	6/0
16	50/1210, 65/680, 80/520	3.9/1.7	1060	13.0	6/0
20A	50/1225, 65/720, 80/525	3.9/1.7	1410	16.0	4/0
30A	50/1805, 65/1065, 80/770	3.9/1.7	1485	15.0	4/0
50A	65/1435, 80/1180, 100/865	3.9/1.7	1575	15.0	4/0
50WA	80/1575, 100/1235, 150/1180	3.1/1.3	2445	20.0	4/0
80WA	100/2445, 150/2365, 200/1920	2.5/1.3	3265	20.0	4/0
130A	150/3315, 200/2770, 250/1955	2.1/1.15	4935	40.0	6/0

TRINIDAD

The Trinidad reel is a brand by itself. World renowned as one of the best saltwater multiplier in the world, the Trinidad A lives up to this legacy. Equipped with the Dartanium II Drag for Higher Pressures and better durability. The Trinidad A is a powerful reel in a compact body.

Model Number	Power Pro Line Capacity [lb/yd]	Gear Ratio	Weight [g]	Max Drag [kg]	Bearings
10A	30/245, 40/230, 50/210	6.3	386	7.5	8/1
12A	40/280, 50/275, 65/175	6.3	391	7.5	8/1
14A	40/375, 50/370, 65/240	6.3	420	7.5	8/1
16NA	50/370, 65/235, 80/190	6.2	547	12.0	8/1
16A	50/530, 65/330, 80/250	6.2	550	12.0	8/1
20A	50/170, 65/375, 80/310	6.2	561	12.0	8/1
30A	50/1015, 65/515, 80/415	6.2	581	12.0	8/1



20 II



20 II



50WA



30A



DIGITAL CONTROL FOR BAITCAST REELS

Avoid backlash with Digital Control in baitcast reels when fishing with medium-heavy (above 16g) lures!

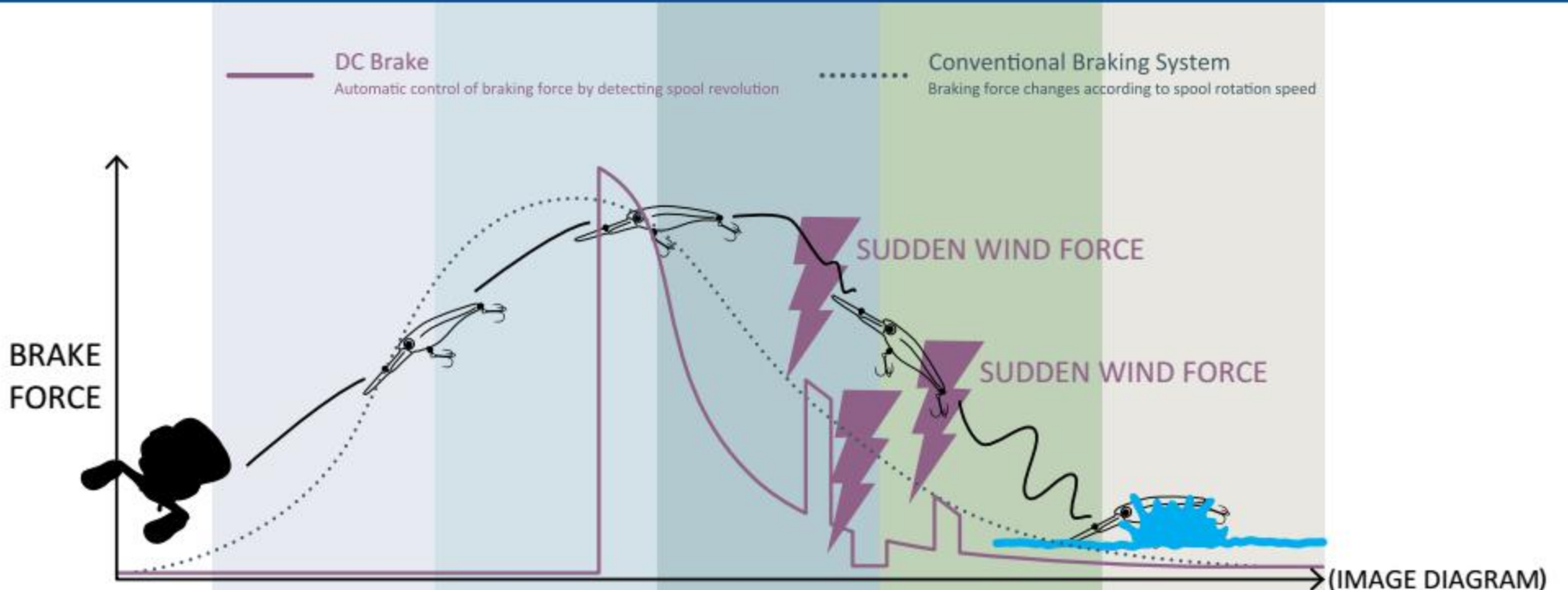

ACTION

CASTING THE LURE

SPOOL ACCELERATION

ENERGY LOSS IN LURE

LURE SLOWS DOWN

LANDING IN WATER

KEY POINT: MINIMUM BRAKING

During this time, spool needs acceleration without any brake force for further casting distance.

Digital Control: Minimum brake force for maximum acceleration.

Centrifugal/Magnetic: Brake force increases as spool acceleration increases.

HIGH CHANCE OF BACKLASH!

Very high chance for backlash due to sudden changes in wind.

Digital Control: Intermittent braking to compensate for wind force effect.

Centrifugal/Magnetic: Brake force does not change with wind, high chance for backlash.

SAFE LANDING

Lure accurately lands in target spot, thumb to stop backlash.

DC system applies the optimum braking for medium-heavy (above 16g) lure fishing by letting the current flow through the coil only when the brake is required from the beginning of casting to the lure landing in water.



BAITCAST/ OVERHEAD



MAINTENANCE TIPS



Tighten cast control cap and star drag before washing



Rinse reel under low pressure water



Rotate spool and rinse for 15-20 seconds



Use a toothbrush to brush handle and star drag area



Use a tube brush to brush reel seat and line guide to ensure salt removal



Spin the reel in fast rotation to channel excess water out



Use a dry cloth to wipe the exterior of the reel.



Remove the side cover and wipe off excessive water droplets.



Loosen star drag and leave it in dry and cool place.

DOS

- ✓ Remove line after deep sea fishing to wash down spool or if intending to keep for long time storage.
- ✓ Avoid placing your reel on boat side rod holders when boat is traveling to prevent splashes of sea water.
- ✓ Put 1-2 drops of oil on main shaft/ line roller/ handle knob bearings/ drive gear bearings and screws after 2-3 times usage.
- ✓ Send for servicing every six months if the reel is being used frequently.

DON'TS

- ✗ Loosen cast control and star drag before washing as water might penetrate into the body
- ✗ Rinse overhead/ baitcast reel on high pressure water.
- ✗ Dipping/ soaking your reel in fresh water
- ✗ Place directly under sunlight after washing.
- ✗ Wash your reel in upside down position.

Note:

This is a general guide for reel maintenance. For detailed reel maintenance, please refer to the product instruction manual.

GIGAMAX MOTOR

**AMAZING PERFORMANCE,
EVEN A RISE IN TEMPERATURE
CANNOT SLOW IT DOWN!**



GIGAMAX

GIGAMAX MOTOR is a brush-less DC Motor. Shimano is the only company that adopts this brush-less motor in electric reels for our BeastMaster series. Inside the motor, there is a special strong magnet that can maintain its performance level even at high temperatures. The motor is specially tuned to meet the reel's specific performance target.

MUTEKI MOTOR

**IMMEDIATE
RESPONSE AT
ITS CORE**

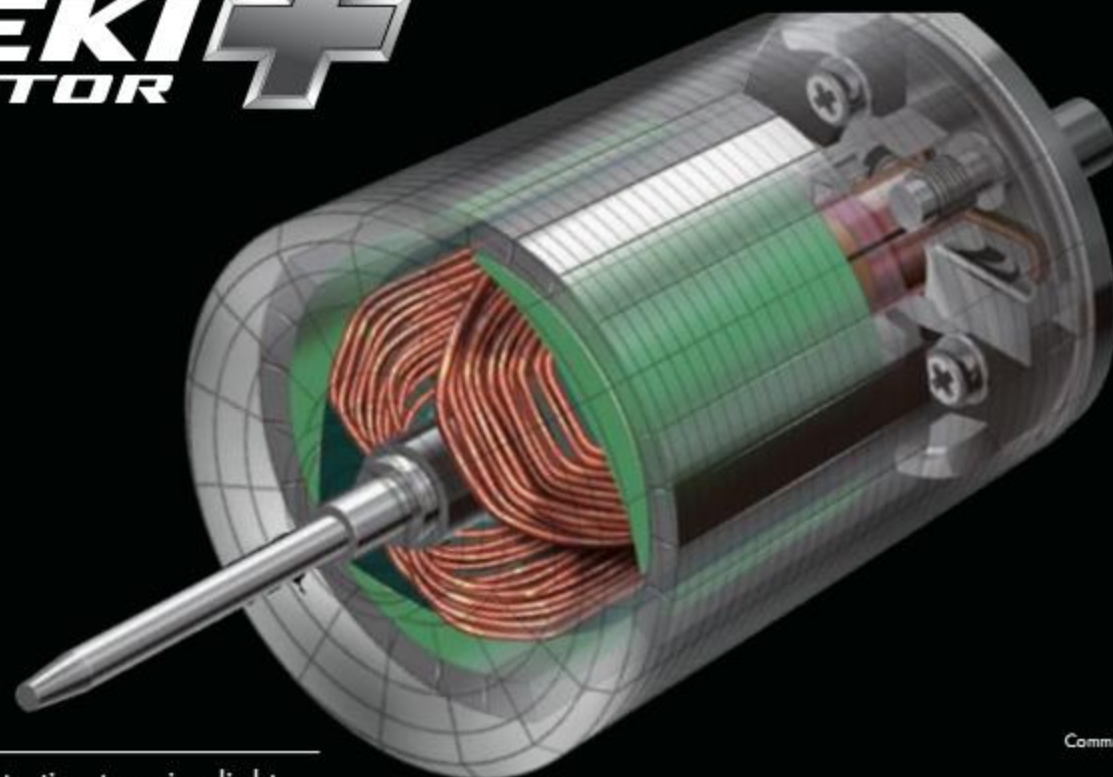

MUTEKI MOTOR

Increasing number of anglers are starting to enjoy light style boat fishing. Understanding this trend, we designed our electric reels to be more compact. While the body size of the reel is smaller, the power and toughness of the reel has improved. By adopting high quality electronic magnets in our MUTEKI MOTOR +, we improve performance of the motor at high temperatures. The torque of the motor is consistent throughout the operation. MUTEKI MOTOR + can be found in the Forcemaster 800 to 3000 size.

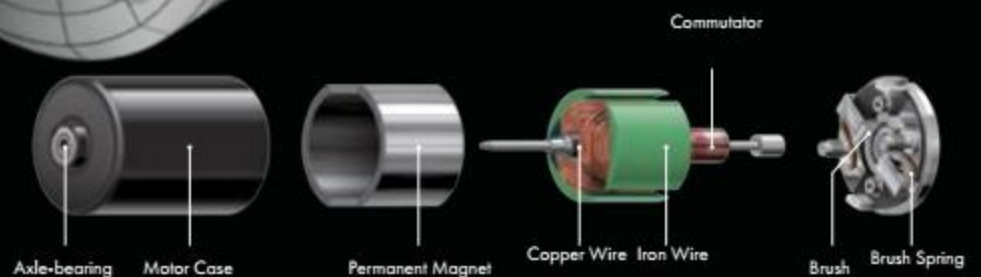

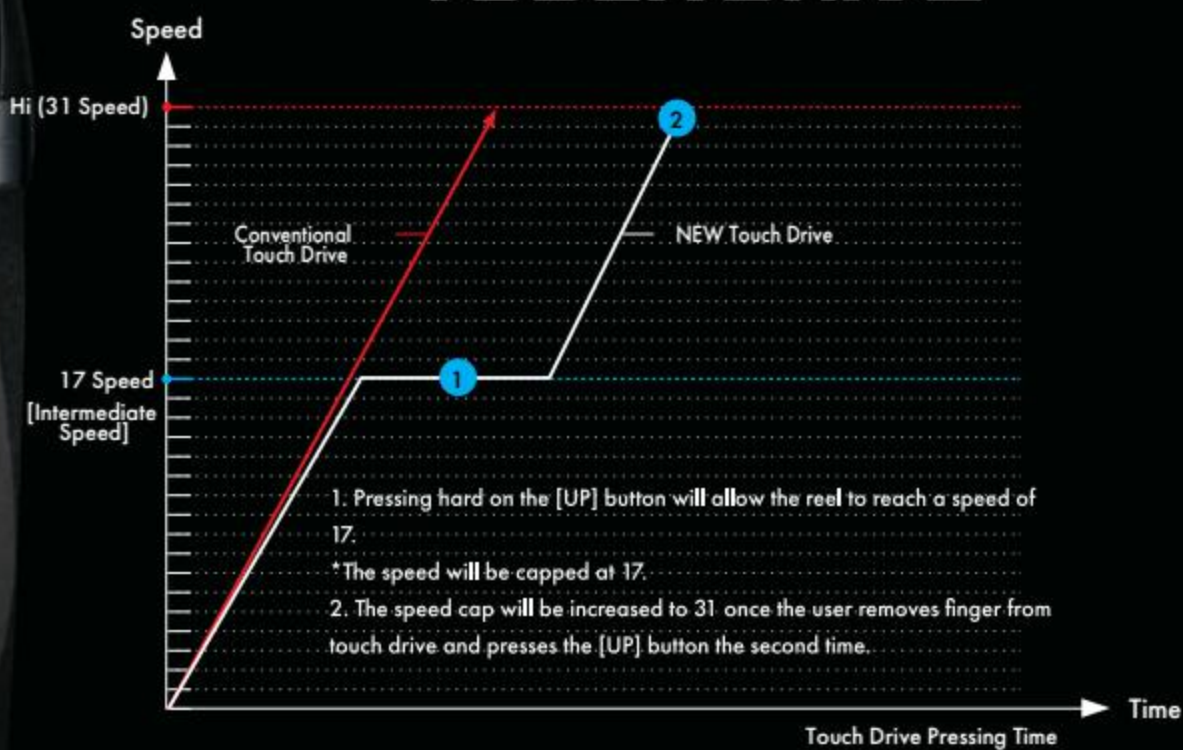

MORE CONTROL AT YOUR FINGERTIPS, WITH A REVAMPED OPERATING SYSTEM - THE NEW TOUCH DRIVE!

A seesaw button configuration installed on the reel allows for quick and precise changes in reeling speed. The speed is adjustable at every stop through a simple press on the buttons. Press the [UP] button to increase the speed by one stop and the [DOWN] button to decrease the speed by one stop. Now available on the BeastMaster 1000EJ and new ForceMaster

601/601DH, this new Touch Drive allows anglers to preset preferred mid-speeds where a single hard press would instantly change the reeling speed from zero to the preferred speed. This new feature helps to prevent a sudden large increase in speed so as to set the hook properly especially for fish where the hook might easily rip off its mouth.

THE REALISATION OF ELECTRIC JIGGING [EJ] BY SHIMANO!

There are 2 modes to the Electric Jigging Operating System
Electric Jigging (EJ) is made up of Manual Mode & Auto Mode.

This EJ system can be found on both the BeastMaster 1000EJ and BeastMaster 2000EJ reels. In Manual Mode, the motor in the reel is engaged only when the [PICK UP] button is pressed. Anglers can also perform numerous combos of jigging styles with different pitches and rod-jerking motions. On the other hand, have absolute control over the pitch and jigging speed when in Auto Mode. SPEED (motor speed), MOVE (duration of motor being engaged), STOP (duration of motor being disengaged) are the new settings the EJ Auto Mode offers to its controller. Set how fast and how long you want the motor to run for and control seamlessly the amount of time you want the motor to stop. The versatility and convenience of this system allows anglers to perform jigging actions using only one arm!



● Auto jerk mode: Typical one-pitch jerk [image]

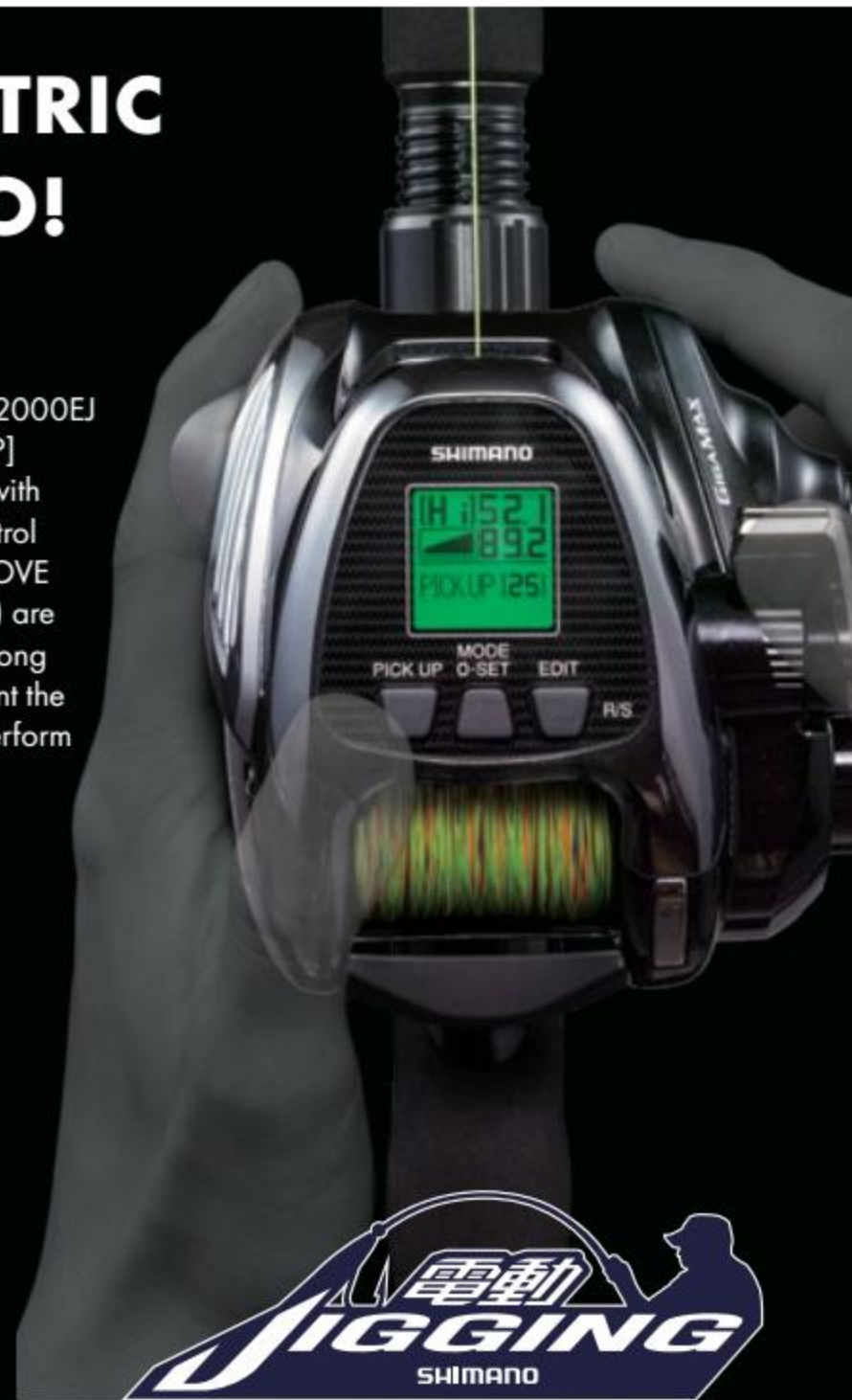

GIGAMAX MOTOR

Low Moment of Inertia (Approximately 5 times lower than normal motor with brush) + Durability!

Line slack for a wider combination of jigging actions!

The most prominent and most attractive feature of the GIGA-MAX motor is its ability to stop completely the spool from rotating once the motor is toggled off. This is made possible by the low Moment Of Inertia of the internal parts of the motor. Due to the lightweight nature of the parts, they are able to be stopped once electricity current to the motor is cut off. Motor off >> Spool stops immediately. Why is this important? It helps to give line slack when the angler needs it to perform a combination of 'SLIDE' and 'FALL' actions on the jigs!

A core tough enough to withstand the most aggressive jigging styles!

The brushless feature of the GIGA-MAX motor mimics the structure of engines used in race cars and bullet trains. The axis of the motor does not come in direct contact with any other parts in the motor. The durability also improves significantly as there is much less friction. The consequences of an electric reel with a less durable motor are no more with the GIGA-MAX motor. Couple this with a gear system with improved strength, perform more aggressive jigging styles with a peace of mind!

40g

50g



● Internal parts of brushless motor (Permanent magnet) ● Internal parts of motor with brush (coils)

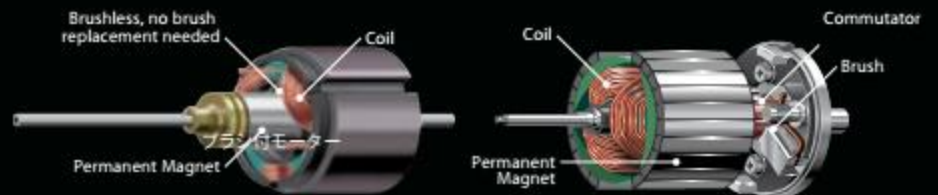

● Brushless Motor

● Motor with Brush

TOUCH DRIVE



A seesaw button configuration installed on the reel allows for quick and precise changes in reeling speed. The speed is adjustable at every stop through a simple press on the buttons. Press the [UP] button to increase the speed by one stop and the [DOWN] button to decrease the speed by one stop. (Refer to Page 43)

● Electric Jigging Technology Specifications

	EJ Mode	GIGA-MAX MOTOR	Reinforced Gear System	NEW Touch Drive
<i>BeastMasterEj</i> 1000	●	●	●	●
<i>BeastMasterEj</i> 2000	●	●	●	

MUTEKI MOTOR+

Highly responsive during operations, the MUTEKI MOTOR+ is a brush motor which displays high levels of torque and power by using a special magnet made from a rare earth.



MUTEKI MOTOR

A brush motor capable of high speed rotations and torque by using Neodymium magnets at its core.



FIRE MACH SYSTEM

In order to provide a smooth switch to reverse rotations, numerous S-ARB (ball bearings) are used to support the main axis of the motor. Similar to the effects of Super Free Spool on smaller sized electric reels, it only requires a small force to slow the spool down from a high rotating speed.



RAKU-RAKU MODE

In this mode, the reel automatically adjusts the line tension according to the load on the other end. This tension is retained throughout the entire fight. This helps to prevent the leader from breaking off the hook or any ruptures in the jaw of the fish.



SPEED MODE

In this mode, the reel maintains the same reeling speed regardless of the change in load on the other end of the line. This mode is suitable for times when power is desired.



TOUCH DRIVE

Using the same hand to hold the rod, the Touch Drive is a see-saw switch allowing for control over the motor speed with just the user's thumb. Use the Touch Drive to your personalised preference to bring up your target from the water.



SMART DIAL

Manage the reeling of electric reels with the smart dial using only your thumbs.



SPEED CLUTCH

Toggle the clutch between ON and OFF with just a simple press on the clutch lever. The lever can also be toggled while thumbing the spool. This helps to prevent troublesome backlash experiences on the reel. Have full confidence that the jig is in the target column as the clutch lever can still be toggled while the spool is being pressed down.



S COMPACT BODY

In addition to making electric reels more compact, the cable connector port is moved to the same side of the handle. This structure helps in providing extra comfort when holding the setup in the palms.



HEAT FREE SYSTEM II

With a vent installed in the reel, heat is expelled quickly from the inner body of the reel (motor), further increasing the heat-removing efficiency of the reel.



THERMO ADJUST DRAG

A control function to suppress abnormal heat generation in the drag section to maintain stable drag performance. There are instances when the drag slips immediately after the motor is turned on and this gives off additional unnecessary heat. When the drag slips, rotation speed of motor is automatically lowered to prevent this additional heat from being generated.



E-EXCITING DRAG SOUND

Digitalizing the exciting drag sound, this feature instills excitement in the angler when fighting fish.



E-CENTERING SYSTEM

The position of the level wind is automatically adjusted to the center after disengaging the clutch and letting 3m of line flow out from the spool. This helps further smoothen the line outlay from the spool.



FINE DOT LCD

A liquid crystal LCD screen with high visibility and hence, operability.



HANDLE SPEED DISPLAY

Displays the rotational speed of the spool when the handle is cranked manually. This measurement is linked to the same standards as the motor speed display. This helps to mimic the personal fishing style of each angler by using the same speed as he/she would on a manual reel.



PERSONALISED JIGGING SETTING

Repeat the same jigging motions on an electric reel with this function. There are altogether 5 settings available with 3 presets (fixed) and 2 customizable options. Use the presets for ease or choose to register your own style of jigging into the 2 customizable settings.

LINKAGE OF MOTOR AND CLUTCH FEATURE

When the clutch is switched OFF while the motor is ON, the motor will be switched OFF together with the clutch. Toggle the clutch ON again and the motor will be switched ON automatically and continue operating.

QUICK AND EASY CONTROL

With a total of 31 levels of speeds to choose from and a mid-speed of 15, this reel now offers more precise speed control to execute jigging actions the way anglers wish.

BeastMaster MD 3000

The torque from the NEW GIGA-MAX motor has been upped 40%! The overwhelming motor power and speed makes the reel a true Monster Drive (MD).

Shimano has successfully incorporated both the power of the BeastMaster 3000XP and the speed of the BeastMaster 3000XS in the latest BeastMaster MD3000, giving it a maximum drag force of 25kg. With the HAGANE body and the upgraded gear system, this electric reel has reached new heights. In addition to the liquid crystal screen making for better visibility during both day and night, the S Compact Body makes palming the reel a more comfortable experience and the large mechanical knob allows for falling action plays underwater.

* Comes with English and Chinese menu.

Model Number	Line Capacity PE [no.-m]	Gear Ratio	Weight [g]	Max Drag [kg]	Max Power [kg]	Speed [m/min]	Bearings
3000	4-470, 5-350, 6-300, 8-200	4.6	1090	25.0	88	215	15/1



BeastMaster EJ 1000

Providing anglers with the highest levels of comfort with both the NEW TouchDrive and SpeedClutch features. A light and subtle yet powerful beast made for e-jigging with the all new EJ mode.

Presenting to all anglers the availability of the EJ mode on the smallest size in the BeastMaster electric reel series - 1000. The reel exhibits high motor speeds and power while keeping a compact and hold-easy body because of the GIGA-MAX motor. With a maximum drag of 15kg and a strength-inclined gear system, this small electric reel is able to conquer even the larger fish species and the durability to execute perfectly trip after trip. Making its first appearance in the BeastMaster series, the NEW TouchDrive enables for swift and accurate control on the motor speed. Though the BeastMaster 1000EJ has an arsenal of features made for e-jigging, this reel is suitable for a variety of Salt Water games thanks to its operability and compact size.

* Comes with English and Chinese menu.

Model Number	Line Capacity PE [no.-m]	Gear Ratio	Weight [g]	Max Drag [kg]	Max Power [kg]	Speed [m/min]	Bearings
1000EJ	3-400, 4-300, 5-230	5.3	700	15.0	68	215	14/1



BeastMaster EJ 2000

Following Spinning and Baitcasting models comes a third option in the jigging field. With the addition of the BeastMaster 2000EJ, Shimano provides all jigging options to anglers especially E-Jigging.

EJ mode helps anglers achieve jerking speeds which can never be achieved by the human hands and allows for control in slide and fall actions of jigs. By stopping the spool at the same time the cranking stops, the brushless GIGA-MAX motor allows anglers to control the line slack freely during jigging motions. The GIGA-MAX motor on the BeastMaster 2000EJ is twice as durable as the 18 BeastMaster 2000 with the strengthened gear system in the reel.

* Comes with English and Chinese menu.

Model Number	Line Capacity PE [no.-m]	Gear Ratio	Weight [g]	Max Drag [kg]	Max Power [kg]	Speed [m/min]	Bearings
2000EJ	3-500, 4-400, 5-300	5.1	690	15.0	68	215	14/1



BeastMaster 2000

The Beastmaster 2000 is equipped with the GIGA-MAX MOTOR boasting high level power and durability, the motor and clutch interlocking function and the ultra-fine shift control, this is a high performance model that adds power to the cool and compact reel. Bringing handheld electric games to the next level, any fish at mid depth becomes a target. Power hidden in a compact a lightweight body.

* Comes with English menu.

Model Number	Line Capacity PE [no./m]	Gear Ratio	Weight [g]	Max Drag [kg]	Max Power (kg)	Speed [m/min]	Bearings
2000	3-500, 4-400, 5-300	5.1	690	15.0	68	215	11/1



BeastMaster 3000XP/3000XS

Shimano is always pushing for more innovation in electric reels. Previously, 3000 size used to be standard size before but nowadays anglers are eager for big motor power in this size. We improved GIGA-MAX motor and transfer the additional power to Power side or Speed side. 3000XP is Power model. 3000XS is Speed model. Even the retrieve power of Speed model is stronger than previous model. Depending on the target fish, you can choose either the Power model or Speed model. In addition to that, the number of drag stack increased from 3 set to 4 set and achieved 20Kg drag power! We also equipped "Fire Mach System" which contribute smooth spool revolution and "Heat Free System II" which release heat to out side so as to maintain reel performance over prolonged fight.

Model Number	Line Capacity PE [no.-m]	Gear Ratio	Weight [g]	Max Drag [kg]	Max Power (kg)	Speed [m/min]	Bearings
3000XP	4-400, 5-350, 6-300, 8-200	3.9	845	20.0	88	170	9/1
3000XS	4-400, 5-350, 6-300, 8-200	3.9	845	20.0	69	215	9/1



3000XS



BeastMaster 6000/9000

The three most important aspects to an electric reel - durability, power and the reel's ability to channel excessive heat to the surroundings. These three criteria have been further evolved on the BeastMaster 6000 and BeastMaster 9000, giving birth to an indestructible machine on the water.

* Comes with English and Chinese menu.

Model Number	Line Capacity PE [no./m]	Gear Ratio	Weight [g]	Max Drag [kg]	Max Power (kg)	Speed [m/min]	Bearings
6000	6-750, 8-600, 10-500, 12-350	3.1	1370	30.0	133	140	16/0
9000	6/1100, 8/900, 10/650, 12/550	3.1	1485	25.0	133	165	14/0



6000

9000



REEL TECHNOLOGY
JDM SPINNING REELS
EXPORT SPINNING REELS
BAITCAST REELS
SW OVERHEAD REELS
ELECTRIC REELS
YUMENA/ GLOSSARY
ROD TECHNOLOGY
SALTWATER RODS
BOAT RODS
BASS RODS
SPECIAL RODS
LIFESTYLE GEAR

ForceMaster 200/200DH NEW

Light game with a compact electric reel.

It is now very possible for anglers to operate electric reels with only one hand with this machine. The side plate has been reduced in area by 20% to give the reel its compact size and light weight. The location of the cable connecting to the battery has also been moved for better comfort when palming the reel. NEW Touch Drive allows medium speed settings while the Speed Clutch allows you to turn the toggle on and off while thumbing the spool. It is also easier to hook on to fish with the gear ratio increased to high gear. With the MUTEKI+ motor, high speed retrieves and jigging actions can be achieved effortlessly.

The motor-clutch synchronization cancels out noise from the motor when the jig "falls" or sinks deeper to the ocean floor. For convenience, you also get the handle speed display to show how fast or slow the handle is being turned at. Rest assured this reel will see you through the toughest of days with an internal labyrinth structure to prevent entry of salt water into the body during fishing. The ForceMaster 200 is a compact and technology-densed electric reel Shimano is proud to present to anglers all around.

* Comes with English menu.

Model Number	Line Capacity PE [no./m]	Gear Ratio	Weight [g]	Max Drag [kg]	Max Power [kg]	Speed [m/min]	Bearings
200	0.8-270, 1-220, 1.5-150	8.2	395	5.0	27	195	9/1
200DH	0.8-270, 1-220, 1.5-150	8.2	395	5.0	27	195	9/1

ForceMaster 600/600DH 601/601DH NEW

The ForceMaster 600 series speedy yet comfortable change in retrieving speed is easily executed with the Touch Drive technology installed on the reinvented electric reel. Anglers are also able to toggle ON/OFF the clutch smoothly with the quick clutch feature. With a miniature body, this electric reel packs a punch with its highest power at 46kg using the MUTEKI MOTOR+ technology. The ForceMaster 600 represents the establishment of advanced technologies used in a whole new generation of electric reels.

* Comes with English menu.

Model Number	Line Capacity PE [no.-m]	Gear Ratio	Weight [g]	Max Drag [kg]	Max Power [kg]	Speed [m/min]	Bearings
600 [R]	2-300, 3-200	5.1	495	8.0	46	195	9/1
600DH [R]	2-300, 3-200	5.1	500	8.0	46	195	9/1
601 [L]	2-300, 3-200	5.1	495	8.0	46	195	9/1
601DH [L]	2-300, 3-200	5.1	500	8.0	46	195	9/1

ForceMaster 800

The ForceMaster 800 electric reel comes with a strong MUTEKI MOTOR+, it breaks down the old concepts and introduces new possibilities to light game electric reel fishing. In addition to the body weight reduction by Shimano's original carbon reinforced material CI4+, SMART CONTROL and ultra-fine shift control are also included.

Model Number	Line Capacity PE [no.-m]	Gear Ratio	Weight [g]	Max Drag [kg]	Max Power [kg]	Speed [m/min]	Bearings
800	2-470, 3-300, 4-230, 5-180	4.4	545	11.5	59	190	10/1



200



600



800



ForceMaster 1000 NEW

Feel the fight even when using an electric reel!

The ForceMaster 1000 brings you both comfort and excitement when it comes to light games as it boasts the power of a size 3000 motor and durability while at the same time, is relatively small and light. Easily operable with only one hand, this reel comes with the NEW Touch Drive and Speed Clutch features. The power of the reel comes from the MUTEKI+ motor while the durability is similar to the BeastMaster 1000EJ as they share the same strengthened gear system. It is a mini spartan with power, speed and toughness!

*Comes with English menu.

Model Number	Line Capacity PE [no./m]	Gear Ratio	Weight [g]	Max Drag [kg]	Max Power [kg]	Speed [m/min]	Bearings
1000	2-600, 3-400, 4-300, 5-200	5.3	680	15.0	62	210	11/1

ForceMaster 2000

The new ForceMaster 2000 has almost the same power as its 3000 size counterpart by adopting high quality electronic magnet motor MUTEKI MOTOR+. Max retrieve speed is 210m/min. Super free spool, e-centering system, sensitive retrieve speed control system and electric constant speed retrieve control. This compact Force Master will open the new gate to power game with light tackle.

Model Number	Line Capacity PE [no./m]	Gear Ratio	Weight [g]	Max Drag [kg]	Max Power [kg]	Speed [m/min]	Bearings
2000	3/500, 4/400, 5/300	5.1	685	15.0	62	210	11/1

ForceMaster 3000XP/3000

The ForceMaster 3000 series reel is built for one purpose, power. The ForceMaster 3000XP is one of the most overwhelming electric reel in the market today. Motor power is greatly enhance in this new model. The brushless design Muteki+ motor is perfect for all day fishing. Additional attention is given to the design of the reel to greatly improve the heat management. This ensure that the performance of the reel is consistent even in prolonged fight.

Shimano ForceMaster continues its compact ergonomic design suited for one-hand operation. The new ForceMaster 3000XP is also lightweight, coming in at 825g, making it a good choice for anglers who prefers to fish with the reel in hand. All-in-all, this reel is one to look out for!

Model Number	Line Capacity PE [no./m]	Gear Ratio	Weight [g]	Max Drag [kg]	Max Power [kg]	Speed [m/min]	Bearings
3000XP	4/400, 5/350, 6/300, 8/200	3.9	825	20.0	69	170	9/1
3000	4/400, 5/350, 6/300, 8/200	3.9	790	20.0	63	210	9/1



1000



2000



3000XP

3000



REEL TECHNOLOGY

JDM SPINNING REELS

EXPORT SPINNING REELS

BAITCAST REELS

SW OVERHEAD REELS

ELECTRIC REELS

YUMEN/A/ GLOSSARY

ROD TECHNOLOGY

SALTWATER RODS

BOAT RODS

BASS RODS

SPECIAL RODS

LIFESTYLE GEAR

ForceMaster 6000 NEW

The long-awaited ForceMaster 6000 will be a must have item in your arsenal when aiming for Yellowfin Tunas and stopping these swimmers in their tracks. Complementing the toughness provided by HAGANE body is a combination of a cold forged aluminium clutch lever and a drag strength of up to 30kg on the reel. A handle knob made of C14+ material adds luxury when held in your hands. With the Heat Free System II, high loads at high temperatures have become a trouble of the past. The latest ForceMaster 6000 is an electric which does not even flinch even when faced with monsters of the deep seas!

* Comes with English menu.

Model Number	Line Capacity PE [no./m]	Gear Ratio	Weight [g]	Max Drag [kg]	Max Power [kg]	Speed [m/min]	Bearings
6000	6-750, 8-600, 10-500, 12-350	3.1	1390	30.0	69	135	5/0



6000



ForceMaster 9000 NEW

With the extra boost in size and power, the ForceMaster 9000 is a must have when venturing into deep sea expeditions. Paired with the HAGANE body on this reel are an improved drag system, a cold forged aluminium clutch lever and the Heat Free System II. The advanced technologies on the reel are what make it possible for this machine to aggressively hunt for the larger species in deeper waters. The new and improved handle knob made with C14+ material assures you of its steady grip while making sure it looks good on you during usage too!

* Comes with English menu.

Model Number	Line Capacity PE [no./m]	Gear Ratio	Weight [g]	Max Drag [kg]	Max Power [kg]	Speed [m/min]	Bearings
9000	6-1100, 8-900, 10-650, 12-550, 15-350	3.1	1495	25	78	140	3/0



PLAYS 600

Plays 600 is a basic model with extensive capabilities for Electric Light Game Fishing styles. With a line capacity of 300m for PE 2.0 lines and 200m for PE 3.0 lines, PLAYS 600 is a model for light game fishing. Although being an electric reel for light game, the power and speed of this reel is comparable to the higher end electric reel models Shimano has to offer.

Featuring Super Free Spool, Raku-Raku mode, Heat Free System and Super Slow Retrieve, this reel is packed with technology and functions an electric reel should have. With a C14+ knob which fits snug when held and a 65mm handle, cranking becomes a comfortable task for anglers.

Model Number	Line Capacity PE [no./m]	Gear Ratio	Weight [g]	Max Drag [kg]	Max Power [kg]	Speed [m/min]	Bearings
600	2-300, 3-200, 4-150	5.0	470	5.0	15	155	5/1

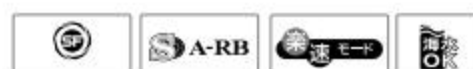

PLAYS 800/1000

The concept of design is "Basic yet Powerful".

Species of small to large sizes all fall into the hit zone of the PLAYS 800/1000. The first part of the concept is "Basic" - to achieve an electric reel capable of being handled in only one hand when involved in light game out at sea. The second part, "Powerful" - to allow anglers to be free of worry when it comes to targeting and hunt for a wide variety of species in terms of size. Small in size it may be, the PLAYS 800/1000 come with the high-functioning MUTEKI MOTOR and low profile made possible with the light and compact design. Providing anglers with an average power of 6kg and a maximum retrieval rate of 190m per minute, these electric reels pride themselves in allowing anglers to be able to hold the reel in one hand while still being able to access the clutch with ease and comfort.

Model Number	Line Capacity PE [no.-m]	Gear Ratio	Weight [g]	Max Drag [kg]	Max Power (kg)	Speed [m/min]	Bearings
800	3-300, 4-250, 4-300, 5-230, 6-180	5.1	615	10.0	49	190	8/1
1000	3-400, 4-300, 5-200	5.1	615	10.0	49	190	8/1

PLAYS 3000XP/3000

Other than the basic model that is the 3000, the power type 3000XP is also in the new line-up. The more powerful 3000XP is decorated with red parts developed by coordinating the use between the speed lever and the handle. Whether it is the powerful 3000XP or the speed focused 3000 model, select the highest performing electric reel of your choice by considering the target fish and the preferred fishing style.

Model Number	Line Capacity PE [no.-m]	Gear Ratio	Weight [g]	Max Drag [kg]	Max Power (kg)	Speed [m/min]	Bearings
3000XP	4-400, 5-350, 6-300, 8-200	3.9	685	15.0	62	150	7/0
3000	4-400, 5-350, 6-300, 8-200	3.9	690	15.0	50	190	7/0

PLAYS 4000

Perfect for light to intermediate deep sea fishing, the PLAYS 4000 churns out an average motor power equivalent to 10kg at a speed of 170m per minute. It is one of the most suitable machines in the lineup when facing large contenders such as the Dogtooth. Being able to hold as much as 500m of PE 6.0 rating line, the electric reel is a primary tool which provides support to anglers who wish to get a taste of the DENDOU action. Its sturdy Hagane body suppresses the reel's tendency to deform, allowing anglers to crank the reel with peace of mind even under high stress loads. With all the advanced technologies including the motor and drag power, the PLAYS 4000 makes an even greater appeal with its reasonable price point.

Model Number	Line Capacity PE [no./m]	Gear Ratio	Weight [g]	Max Drag [kg]	Max Power (kg)	Speed [m/min]	Bearings
4000	5/600, 6/500, 8/300, 10/270	3.2	1230	15.0	50	170	2/0



1000



3000XP



REEL TECHNOLOGY

JDM SPINNING REELS

EXPORT SPINNING REELS

BAITCAST REELS

SW OVERHEAD REELS

ELECTRIC REELS

YUMEN/A/ GLOSSARY

ROD TECHNOLOGY

SALTWATER RODS

BOAT RODS

BASS RODS

SPECIAL RODS

LIFESTYLE GEAR



ELECTRIC REEL

MAINTENANCE TIPS



1 Tighten star drag and cast control cap before washing



2 Cover socket with rubber socket cap

DOS

- ✓ Wash your reels with warm water (under 30 degrees Celcius).
- ✓ Detergent can be used if stub born stains could not be removed.
- ✓ Washing your reels after every trip
- ✓ Remove line after deep sea fishing or intending to keep for long time storage.
- ✓ Avoid placing the reel on boat side rod holders to prevent splashes of sea water



3 Quick run through of low pressure water on screen (not more than 3 seconds)



4 Rinse the spool area for removal of remaining salt

DON'TS

- ✗ Wash the screen for too long as water might penetrate
- ✗ Wash the reel when the motor is still hot
- ✗ Do not use chemicals like gasoline/kerosene/Benzene to wash down reel as it will damage the coating
- ✗ Wash your reel when the socket is not covered
- ✗ Wash when star drag and cast control is not tightened
- ✗ Dip or soak the whole reel into a bucket of fresh water
- ✗ Using high pressure water to wash down your electric reel
- ✗ Place under direct sunlight after washing



5 Engage clutch and pull out 2-3 meter of line while running low pressure water



6 Use a toothbrush to brush the handle shank and handle knob area



7 Use a tube brush to brush small accessible area (Reel seat, Line guide area) TO ENSURE removal of remaining salt



8 Use a wet cloth to wipe down the whole reel to ensure remaining salt and bait is removed



9 Use a dry cloth to wipe down completely



10 Use an air duster to spray difficult access area to clear off water droplets































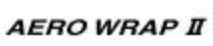

11 Loosen star drag and leave in a dry and cool place

Note:
This is a general guide for reel maintenance. For detailed reel maintenance, please refer to the product instruction manual.



GLOSSARY

Reel Technology	Explanation	Reel Technology	Explanation
 HG GEAR	HAGANE GEAR Hagane is the concept of power. By using a cold forging technique, we produced a class-leading drive gear that is stronger and more durable.	 S3D	S3D The Shimano Stable Spool Design technology features balanced and uniform thin wall aluminium construction throughout the spool. This precision significantly reduces spool vibration and creates an incredibly smooth feeling when casting and retrieving.
 MICROMODULE	MICROMODULE With gear teeth super-refined to the limit, the "Micro Module Gear System" enables seamless engagement and power transmission. The System, without compromising strength, reduces noise and provides you with far better sensitivity.	 I-DC+	I DC+ I DC + is the latest development in automatic cast control. This new digitally controlled braking system makes adjustments by the angler unnecessary, resulting in smoother, more accurate and backlash free casts.
 X-SHIP	X-SHIP X-SHIP stands for Extra, Smooth and High Power. By supporting the pinion gear on both ends with S A-RB bearings (on Stella models) and introducing a bigger drive gear, Shimano increased gearing efficiency and high power. This results in a fishing reel with ultra-light handle rotation for less effort, even under heavy loads. This increases the efficiency of the reel, meaning it will stay smoother and perform at its peak for much longer	 SVS	SVS INFINITY SVS Infinity provides 4-6 settings and an adjustable brake dial to provide a much wider and more precise range for maximum control and consistent brake performance in all conditions.
 HG BODY	HAGANE BODY The Hagane body is a metal reel body with high rigidity. The body stiffness and impact resistance virtually eliminates body flexing. The result transforms the angler's actions directly into cranking power.	 E-EXCITING DRAG SOUND	EXCITING DRAG SOUND This audible and highly exciting sound, which occurs when a fish runs, is a modern alternative to the traditional clicker or ratchet.
 MGL ROTOR	MGL ROTOR The redesigned Magnumlite Rotor delivers ultra light, almost friction free rotation, enabling you to control the retrieve with ultimate precision and sensitivity. Lures become even more animated when using the MGL Rotor reel, and the ultra light experience lets you feel every movement of the lure, the bottom and ultimately the strike of the fish, no matter how slight it is.	 S COMPACT BODY	S COMPACT BODY Compact body design to reduce weight and allow for better grip and leverage while fighting a fish.
 COREPROTECT	CORE PROTECT The concept of Core Protect is simple, to provide water resistance without creating a heavy rotation feeling. There are three key areas of the reel that require protection: the roller clutch, the body and the line roller.	 X DRAG	X DRAG It's all about leverage! We've repositioned the reel handle closer to the body to increase cranking leverage, rigidity and torque, as found in the Calcutta D reels.
 G FREE BODY	G FREE BODY G Free Body technology has been developed to shift the reel's centre of gravity closer to the rod. This has been achieved by moving the oscillation mechanism 19mm up from the bottom of the reel to the top. By moving the centre of gravity closer to the angler's hand position, the G Free Body helps to reduce fatigue and enhances casting comfort.	 RIGID SUPPORT DRAG	RIGID SUPPORT DRAG Rigid support drag eliminates spool movement and wobble, even at light drag settings. The result is an incredibly smooth drag even at extremely light settings.
 X SHIELD	X-SHIELD By placing sealing gaskets in 12 critical locations throughout the rigid aluminium body, we are able to create a water resistant structure that can hold up against the toughest conditions and fish that Mother Nature has to offer.	 S A-RB	S A-RB Shielded Anti-Rust bearings are similar to A-RB, but feature additional shields for the ultimate protection.
 X PROTECT	X-PROTECT The first in lip in the proprietary three-lipped rubber seal system is designed to keep low pressure water out. The grease between the second and third lips resists high pressure water while enhancing a smooth rotor rotation.	 A-RB	A-RB Anti-Rust Bearing possess extreme durability, at least 10 times the corrosion resistance of standard stainless steel bearing.
 X TOUGH DRAG	X-TOUGH DRAG Incorporating large diameter drag washers at the base of the spool provides greater drag stability. The result is smooth and consistent drag performance throughout the fight. The Coil Wave Spring features steady elasticity at any compression level, and little deformation under repeated compression. This results in precise drag adjustments throughout the curve, giving the angler more control at high pressure.	 ONE-PIECE BAIL	ONE-PIECE BAIL One piece bail allows the line to travel unimpeded to the line roller. Its seamless design reduces friction and the chance of tangles or cut to the bail arm.
 AR-C SPOOL	AR-C SPOOL Through tens of thousands of casting tests and computer simulations, it has been determined that AR-C spool lip design produces longer casting distances than a standard spool lip, while preventing backlashes and wind knots from forming. It also allows the line to flow off the spool in smaller loops during the cast, which means less slap on the strip per guide. This results in longer casts with less friction.	 SUPER FREE SPOOL	SUPER FREE SPOOL Eliminates friction on the spool shaft for increased free spool. The result is a longer cast requiring less effort.
 CI4	CI4 CI4 is a material created by the interfusion of carbon and polyamide. The upshot is a reel whose precision inner workings are housed within a protective shell with all the performance advantages of metal, but weighing less and therefore reducing arm fatigue whilst increasing feel and balance throughout the rod.	 AERO WRAP II	AERO WRAP II Aerowrap II is a worm gear oscillation system with a specially designed pitch to create optimal oscillation speeds for the AR-C lip design. It provides uniform line lay and winding shape to prevent loss of energy during a cast, while providing longer casts than other oscillation systems.
 CI4+	CI4+ We have upgraded our light-weight carbon material CI4. Keeping it light weight, rigidity and durability of the material under fishing conditions are highly improved. From this characteristic, we were able to reduce the volume and weight of the rotor and the body.	 VARISPEED II	VARISPEED II Varispeed with extra teeth on the main gear to enhance line lay.
 LONG STROKE SPOOL	Long Stroke Spool The long stroke spool design improves casting performance when compared to the previous model due to the improved line flow from the spool.	 VARISPEED	VARISPEED Consistent spool speed is achieved by altering the speed of the oscillation cam. This results in an even line lay, delivering excellent casting and overall manageability.
		 TOUCH DRIVE	Touch Drive Anglers can now easily choose the exact level of speed required, making even super slow retrieves possible with this electric reel. Touch Drive [] can also be accessed through the mode setting on the electric reel.
		 HEAT SINK DRAG	Heat Sink Drag By installing a heat sink panel which channels heat generated from the drag away from the spool, the negative effects of high heat on the spool have been successfully reduced by 50%. A heat insulator sheet is also installed to ensure the heat away from the lines on the spool, resulting in a 30% drop in temperature increments in the line filled area of the spool.
		 MGL SPOOL III	Magnumlite spool III The thickness of walls of the spool is minimized without compromising the spool's durability, resulting in a successful reduction in moment of inertia. The NEW Antares is equipped with a 34mm diameter and 19mm width narrow MGL III spool. The moment of inertia of the new spool has been successfully reduced by 15% compared to its predecessor (2nd gen MGL spool).
		 FALL LEVER	Fall Lever Controlling fall speeds with ease and comfort with an all new design. Previously a complicated part of the fishing sport, controlling the fall speed has been made easy and accurate with the fall lever function. Anglers are able to formulate a more strategic approach to fishing for their targets by adjusting different fall speeds in different columns of the ocean. The shape of the lever allows itself to fit perfectly on the reel without disrupting the smooth operability of the reel.

REEL TECHNOLOGY
JDM SPINNING REELS
EXPORT SPINNING REELS
BAITCAST REELS
SW OVERHEAD REELS
ELECTRIC REELS
YUMEA / GLOSSARY
ROD TECHNOLOGY
SALTWATER RODS
BOAT RODS
BASS RODS
SPECIAL RODS
LIFESTYLE GEAR

STELLA



SPOOL S-27



YUMEYA 18 STELLA 1000 F3 SPOOL

Item Name	Drag Power (kg)	Weight (g)	Spool Design (Dia mm/ Float mm)	Line Capacity	No. of Bearing	Item Code
1000 F3 Spool	2	24	40/13.5	Fluoro (lb-m) 2-120, 3-100, 4-80	1	03969



SPOOL (1000) S-27
SPOOL (2500) S-20



YUMEYA 18 STELLA 1000 N4010/1000/2500 F6 SPOOL

Item Name	Drag Power (kg)	Weight (g)	Spool Design (Dia mm/ Float mm)	Line Capacity	No. of Bearing	Item Code
1000 N4010 SPOOL	2	23	40/13.5	PE (No-m) 0.15-150, 0.8-110, 1-80	1	03900
1000 SPOOL	2	20	40/13.5	PE (No-m) 0.8-240, 1-190	1	03907
2500 F6 SPOOL	2.5	28	47/17	PE (No-m) 0.8-200, 1-160, 1.2-130	1	03901

SPOOL S-27



YUMEYA 18 STELLA C2000 F6 SPOOL

Item Name	Drag Power (kg)	Weight (g)	Spool Design (Dia mm/ Float mm)	Line Capacity	No. of Bearing	Item Code
C2000 F6 SPOOL	2	24	43/13.5	Fluoro (lb-m) 5-130, 6-100, 8-75	1	03970

SPOOL S-27



YUMEYA 18 STELLA 2500 F3/2500 F4 SPOOL

Item Name	Drag Power (kg)	Weight (g)	Spool Design (Dia mm/ Float mm)	Line Capacity	No. of Bearing	Item Code
2500 F3 SPOOL	2.5	30	47/17	Fluoro (lb-m) 2-120, 3-100, 4-80	1	03972
2500 F4 SPOOL	2.5	30	47/17	Fluoro (lb-m) 2-120, 3-100, 4-80	1	03973

SPOOL S-20



YUMEYA 18 STELLA 2500 PE0815 SPOOL

Item Name	Drag Power (kg)	Weight (g)	Spool Design (Dia mm/ Float mm)	Line Capacity	No. of Bearing	Item Code
2500 PE0815 SPOOL	6	30	47/17	PE (No-m) 0.6-200, 0.8-150, 1-110	1	03974



SPOOL S-20



YUMEYA 18 STELLA 2500 PE0820/2500 PE 1215 SPOOL

Item Name	Drag Power (kg)	Weight (g)	Spool Design (Dia mm/ Float mm)	Line Capacity	No. of Bearing	Item Code
2500 PE0820 SPOOL	6	32	47/17	PE (No-m) 0.8-200, 1-160, 2-130	1	03902
2500 PE1215 SPOOL	6	34	47/17	PE (No-m) 1-190, 2-150, 1.5-210	1	03903

SPOOL S-28



YUMEYA 18 STELLA 4000PE 1515/4000PE 1520 SPOOL

Item Name	Drag Power (kg)	Weight (g)	Spool Design (Dia mm/ Float mm)	Line Capacity	No. of Bearing	Item Code
4000PE 1515 SPOOL	7	50	52/19	PE (No-m) 1.2-190, 1.5-150, 2-130	1	03975
4000PE 1520 SPOOL	7	45	52/19	PE (No-m) 1.2-250, 1.5-200, 2-150	1	03976

SPOOL S-28



YUMEYA 18 STELLA 4000 PE1015/4000 PE1215/4000 PE2020 SPOOL

Item Name	Drag Power (kg)	Weight (g)	Spool Design (Dia mm/ Float mm)	Line Capacity	No. of Bearing	Item Code
4000 PE1015 SPOOL	7	54	52/19	PE (No-m) 0.8-190, 1-150, 1.5-100	1	03904
4000 PE1215 SPOOL	7	53	52/19	PE (No-m) 1-190, 2-150, 1.5-120	1	03905
4000 PE2020 SPOOL	7	50	52/19	PE (No-m) 1.5-265, 2-200, 2.5-160	1	03906

COLTSNIPER



SPOOL S-28



YUMEYA CUSTOM SPOOL 4000 PE1520 /4000 PE2020 (COLTSNIPER COLOR)

Item Name	Drag Power (kg)	Weight (g)	Spool Design (Dia mm/ Float mm)	Line Capacity	No. of Bearing	Item Code
4000 PE 1520 SPOOL	11	45	52.0/19.0	PE (No-m) 1.2-250, 1.5-200, 2-150	1	04106
4000 PE 2020 SPOOL	11	47	52.0/19.0	PE (No-m) 1.5-265, 2-200, 2.5-160	1	04107

Soare



SPOOL S-29



YUMEYA CUSTOM SPOOL (SOARE COLOR)

Item Name	Drag Power (kg)	Weight (g)	Spool Design (Dia mm/ Float mm)	Line Capacity	No. of Bearing	Item Code
1000 N4010 SPOOL	3	25	40.0/13.5	PE (No-m) 0.6-150, 0.8-110, 1-80	1/0	04102
C2000 N4010 SPOOL	3	24	40.0/13.5	PE (No-m) 0.3-120, 0.4-90	1/0	04103



SPOOL (PE0315) S-4



YUMEYA SPOOL TYPE II (SOARE COLOR)

Item Name	Drag Power (kg)	Weight (g)	Spool Design (Dia mm/ Float mm)	Line Capacity	Item Code
PE0315 (S-4)	2.5	31	43/14.5	PE (No-m) 0.3-150, 4-120	03016

EXSENCE



SPOOL S-20



YUMEYA CUSTOM SPOOL 2500 PE1215/ 4000 PE1215 (EXSENCE COLOR)

Item Name	Drag Power (kg)	Weight (g)	Spool Design (Dia mm/ Float mm)	Line Capacity	No. of Bearing	Item Code
2500 PE1215 SPOOL	9	31	47.0/17.0	PE (No-m) 1-190, 1.2-150, 1.5-120	1	04104
4000 PE1215 SPOOL	11	45	52.0/19.0	PE (No-m) 1-190, 1.2-150, 1.5-120	1	04105

Sephia



SPOOL S-20



YUMEYA CUSTOM SPOOL 2500PE 0815 /2500PE 0820 SPOOL (SEPHIA COLOR)

Item Name	Drag Power (kg)	Weight (g)	Spool Design (Dia mm/ Float mm)	Line Capacity	No. of Bearing	Item Code
2500PE 0815 SPOOL	9	31	47/17	PE (No-m) 0.6-200, 0.8-150, 1-120	1	04058
2500PE 0820 SPOOL	9	33	47/17	PE (No-m) 0.6-200, 0.8-150, 1-120	1	04059



SPOOL S-4



YUMEYA CUSTOM SPOOL 2500PE 0815 /2500PE 0820 SPOOL (SEPHIA COLOR)

Item Name	Drag Power (kg)	Weight (g)	Spool Design (Dia mm/ Float mm)	Line Capacity	Item Code
PE0815 SPOOL	3.5	37	46.5/14.5	PE (No-m) 0.4-210, 0.6-150, 0.8-100	03017
PE0820 SPOOL	3.5	34	46.5/14.5	PE (No-m) 0.8-200, 1-150, 1.2-100	03018

STELLA SW

SPOOL S-29



YUMEYA 20 STELLA SW18000 POWER HOOKING SPOOL						
Item Name	Drag Power (kg)	Weight (g)	Spool Design (Dia mm/ Float mm)	Line Capacity	No. of Bearing	Item Code
18 POWER H-SP	17	185	72.0/28.0	PE (No-m) 5-500, 6-400, 8-300	2	04251

SPOOL S-29



YUMEYA 20 STELLA SW20000 MAX SPOOL						
Item Name	Drag Power (kg)	Weight (g)	Spool Design (Dia mm/ Float mm)	Line Capacity	No. of Bearing	Item Code
20MAX-SP	17	215	80.0/28.0	PE (No-m) 6-600	2	04252

Handle Knob TYPE A

Handle Knob A



YUMEYA HANDLE KNOB EVA ROUND TYPE S		
Item Name	Weight (g)	Item Code
Round S	9	04030



Handle Knob A



YUMEYA HANDLE KNOB I-SHAPE TYPE SS		
Item Name	Weight (g)	Item Code
I type SS	2.3	03909



Handle Knob A



YUMEYA ALUMINIUM ROUND POWER KNOB		
Item Name	Weight (g)	Item Code
BLACK/ GOLD S	19	02712
BLACK/ GOLD M	25	02627
BLUE S	19	02713
BLUE M	25	02682
GREY S	19	02714
GREY M	25	02683



Handle Knob A



HANDLE KNOB EVA I-SHAPE LONG		
Item Name	Weight (g)	Item Code
EVA LONG HANDLE KNOB I	7	02616



Handle Knob A



YUMEYA EVA POWER ROUND HANDLE KNOB		
Item Name	Weight (g)	Item Code
EVA POWER ROUND KNOB M	11	02635



Handle Knob A
HANDLE H-2



YUMEYA ALUMINIUM DOUBLE HANDLE 45MM				
Item Name	Weight (g)	Length (mm)	No. of Bearings	Item Code
ALUMINIUM DOUBLE HANDLE 45MM	46	45	2	03434



Handle Knob TYPE B

HANDLE KNOB B
HANDLE (48mm) BH-1
HANDLE (55mm) BH-2



YUMEYA ULTRA STRONG HANDLE 48MM / 55MM				
Item Name	Weight (g)	Length (mm)	No. of Bearings	Item Code
48MM	TBC	48	4	04373
55MM	TBC	55	4	04374



HANDLE KNOB B



YUMEYA RUBBER T-TYPE POWER HANDLE		
Item Name	Weight (g)	Item Code
RUBBER T-TYPE HANDLE KNOB M	37	03585



HANDLE KNOB B



YUMEYA C14+ ROUND HANDLE KNOB L		
Item Name	Weight (g)	Item Code
C14+ ROUND HANDLE KNOB	26	03586



HANDLE KNOB B



YUMEYA EVA POWER ROUND KNOB L		
Item Name	Weight (g)	Item Code
EVA POWER ROUND KNOB L	18	02630



HANDLE KNOB B



YUMEYA ALUMINIUM POWER ROUND KNOB		
Item Name	Weight (g)	Item Code
BLACK/ GOLD M	26	02628
BLACK/ GOLD L	32	02629
BLUE M	26	02684
BLUE L	32	02686
GREY M	26	02685
GREY L	32	02687



REEL TECHNOLOGY

JDM SPINNING REELS

EXPORT SPINNING REELS

BAITCAST REELS

SW OVERHEAD REELS

ELECTRIC REELS

YUMEYA/ GLOSSARY

ROD TECHNOLOGY

SALTWATER RODS

BOAT RODS

BASS RODS

SPECIAL RODS

LIFESTYLE GEAR

[SPINNING REEL]

YEAR	MODEL NAME	SIZE	DRAG KNOB	SPOOL	REEL STAND	HANDLE	HANDLE KNOB	HANDLE SCREW CAP
2019	STELLA	C2500SXG	—	S-27	C/D	H-11	A	HC-2
		C3000SDH	—	S-20	C/D	H-11	A	HC-2
		C5000HG	—	S-28	C/D	H-11	A	HC-2
2018	STELLA	1000SSSPG/1000SSSDH/C2000S/C2000SHG	—	S-27	C	H-10	A	HC-1
		C2500SHG	—	S-27	C/D	H-11	A	HC-2
		2500S/2500SHG/C3000/C3000SDH/C3000HG/C3000MHG/3000MHG	—	S-20	C/D	H-11	A	HC-2
2019	VANQUISH	4000/4000XG/4000MHG/C5000XG	—	S-28	C/D	H-11	A	HC-2
		1000SSSPG/C2000S/C2000SS/C2000SHG	—	S-27	C/D	H-10	A	HC-1
		C2500SHG/C2500SXG	—	S-27	C/D	H-11	A	HC-2
2020	TWIN POWER	2500S/2500SHG/C3000/C3000MHG/C3000XG	—	S-20	C/D	H-11	A	HC-2
		3000MHG	—	S-20	C/D	H-11	A	HC-2
		4000/4000PG/4000MHG/4000XG/C5000XG	—	S-28	C/D	H-11	A	HC-2
2021	TWINPOWER XD	C3000HG/C3000XG	—	S-20	C	H-11	A	HC-2
		4000PG/4000HG/4000XG/C5000XG	—	S-28	C	H-11	A	HC-2
2017	SUSTAIN	C3000HG	—	S-23	C	H-2	A	HC-2
		3000XG	—	S-23	C/D	H-2	A	HC-2
		4000XG/C5000XG	—	S-24	C/D	H-2	A	HC-2
2020	VANFORD	C2000S/C2000SHG	—	S-27	C	H-10	A	HC-1
		C2500SHG	—	S-27	C/D	H-11	A	HC-2
		2500S/2500SHG/C3000/C3000SDH/C3000HG/C3000XG/3000MHG	—	S-20	C/D	H-11	A	HC-2
2019	STRADIC	4000/4000MHG/4000XG/C5000XG	—	S-28	C/D	H-11	A	HC-2
		1000S/C2000S/C2000SHG	—	S-27	C	H-10	A	HC-1
		2500S/2500SHG/C3000/C3000HG/C3000XG/3000MHG	—	S-20	C/D	H-11	A	HC-2
2021	ULTEGRA	1000/C2000S/C2000HGS	—	—	C	H-10	A	HC-1
		2500/2500SHG/C3000/C3000HG/C3000XG	—	—	C	H-11	A	HC-2
		4000/4000XG/C5000XG	—	—	C	H-11	A	HC-2
2021	EXSENCE	C3000MHG/C3000M/3000MHG	—	S-20	C	H-11	A	HC-2
		4000MXG	—	S-28	C	H-11	A	HC-2
2018	EXSENCE CI4+	C3000M/C3000MHG	—	S-23	C	H-2	A	HC-2
		3000MHG	—	S-23	C/D	H-2	A	HC-2
		4000MXG	—	S-24	C/D	H-2	A	HC-2
2020	EXSENCE BB	C3000MHG	—	—	C	H-2	A	HC-2
		3000MHG	—	—	C	H-2	A	HC-2
		4000MHG / 4000MXG	—	—	C	H-2	A	HC-2
2015	AR-C AERO BB	C3000HG	—	—	—	—	A	—
2014		4000/4000HG	—	—	D	—	A	HC-2
2019	SEPHIA SS	C3000S / C3000SDH / C3000SHG / C3000SDHGG	—	S-23	C	H-2	A	HC-2
2017	SEPHIA CI4+	C3000S/C3000SDH/C3000SHG/C3000SDHGG	—	S-23	C	H-2	A	HC-2
2018	SEPHIA BB	C3000S/C3000SHG/C3000SDH/C3000SDHGG	—	—	C	H-2	A	HC-2
2018	SOARE CI4+	500S	—	—	C	H-1	A	HC-1
		C2000SS PG	—	S-22	C	H-1	A	HC-1
		2000S HG	—	S-25	C	H-2	A	HC-2
2018	SOARE BB	500S/C2000SSPG/C2000SSHG	—	—	C	H-1	A	HC-1
2018	CARDIFF CI4+	1000S/1000SHG	—	S-22	C	H-1	A	HC-1
		C3000MHG	—	S-23	C	H-2	A	HC-2
2021	COMPLEX XR	C2000S F4/C2000S F4 HG	—	S-27	C	H-10	A	HC-1
2010	AORISTA CI4	2500S F6/2500S F6 HG	—	S-20	C	H-11	A	HC-2
2013	AORISTA BB	2500/C3000HG/4000	—	—	—	—	A	—
2020	STELLA SW	4000HG/4000XG	—	S-3 S-28	D	—	B	HC-2
		5000HG/5000XG/6000PG/6000HG/6000XG	D-6	S-7	D	—	B	HC-2
		18000HG/20000PG	—	S-29	—	H-12	B	—
2019	TWIN POWER SW	3000	—	—	—	—	B	—
		8000HG/8000PG	D-7	—	—	H-4	B	—
		10000PG/14000XG/14000PG	D-7	S-10 S-17	—	H-4	B	—
2021	TWIN POWER SW	4000XG	—	S-3 S-28	D	—	B	HC-2
		5000HG/5000XG/6000PG/6000HG/6000XG	D-6	S-7	D	—	B	HC-2
		8000PG/8000HG	D-7	—	—	H-4	B	—
2020	STRADIC SW	10000PG/10000HG/14000PG/14000XG	D-7	S-17	—	H-4	B	—
		4000HG/4000XG	—	S-28	C/D	H-11	B	HC-2
		5000PG/5000XG/6000PG/6000HG/6000XG	—	—	—	—	B	HC-2
2019	SPHEROS SW	8000PG/8000HG/10000HG	—	—	—	—	B	—
2014		3000XG / 4000HG / 4000XG	—	—	C/D	H-2	A	HC-2
2014	5000HG/6000HG/6000PG/8000HG/8000PG	—	—	D	—	B	—	

[LEVER BRAKE REEL]

YEAR	MODEL NAME	SIZE	DRAG KNOB	SPOOL	REEL STAND	HANDLE	HANDLE KNOB	HANDLE SCREW CAP	BRAKE LEVER
2015	BB-X TECHNIUM	2500DXG S LEFT/C3000DXG S LEFT/ C3000DXG S RIGHT	—	B-1	—	EXCLUSIVE PARTS	A	—	L-1
2020	BB-X HYPERFORCE	C3000DXG/C4000D TYPE-G	—	B-1	—	H-9	A	—	L-1
		1700DXG/C2000DXG/C2000DXG/PE08DXG	—	B-4	C/D *1	H-2	A	HC-2	L-1
2017	BB-X HYPERFORCE	2500DXG S LEFT/C3000D TYPE-G S RIGHT/C3000DXG S LEFT	—	B-1	—	—	A	—	L-1
		C3000DXG S RIGHT/C3000DXG S RIGHT/C4000DXG S LEFT	—	B-1	—	—	A	—	L-1
2016	BB-X DESPINA	2500DHG/2500DXG/C3000DHG/C3000-TYPE-G	—	B-1	C/D	H-2	A	HC-2	L-1
2016	BB-X LARISSA	2500DHG/2500DXG/C3000DHG/C3000DXG	—	B-1	C/D	H-2	A	HC-2	L-1
2018	BB-X RENMARE	5000DHG	—	B-2	C/D	—	A	HC-2	L-1
		6000D/8000D	—	B-3	C/D	—	A	HC-2	L-1
2015	BB-X RENMARE RINKAI SP	1700DXG	—	B-4	C/D *1	H-2	A	HC-2	L-1

*1 COMPATIBLE WITH C TYPE REEL STANDS. HOWEVER, IN THE EVENT THAT THERE ARE GAPS OR DIFFICULTIES IN PLACING THE REEL ON THE C-TYPE STAND, PLEASE REMOVE THE O-RING ON THE SIDE OF THE REEL STAND.

※THE COLOUR ON THE LEFT INDICATES THAT OTHER PARTS ARE REQUIRED FOR FITTING. PARTS INCLUDED ARE HANDLE BOLT (CODE NO.: 70710252500) AND WASHER (CODE NO.: 70725481000). IN ADDITION, THIS MEANS THAT THE HANDLE WOULD NOT BE COLLAPSIBLE.

YEAR	MODEL NAME	SIZE	SPOOL	HANDLE	HANDLE KNOB
2017	FLIEGEN	35 THIN+/ 35 THIN	C-1	—	A
2017	FLIEGEN SD	35 STANDARD	—	—	A
2018	SURFLIDER CI4+	35 THIN+/35 THIN	C-1	—	A
		SD35 STANDARD/30THIN+/30 THIN	—	—	A
2015	SUPER AERO SPIN JOY SD	35 STANDARD	S-14	—	—
2014	SUPER AERO SPIN JOY	35 THIN/35 STANDARD	C-1	—	—
2013	POWER AERO SPIN POWER	STANDARD/THICK/THICK+	P-1	—	B
2015	POWER AERO PRO SURF	STANDARD/THICK/THICK+	—	—	B
2014	BULLSEYE	5050/5080	—	—	B
		9100/9120	S-14	—	B

YEAR	MODEL NAME	SIZE	HANDLE	HANDLE KNOB	YEAR	MODEL NAME	SIZE	HANDLE	HANDLE KNOB
2021	ANTARES DC	R/L・HG R/L・XG R/L	BH-1	A	2017	STILE SS	150PG/151PG/150HG/151HG	BH-1	A
2018		MD XG R/MD XG L	BH-1	A	2016	STILE	100PG/101PG/100HG/101HG/100XG/101XG	BH-1	A
2019	ANTARES	R/R/HG R/HG L	—	A	2017	STEPHANO SS	100HG/101HG	—	A
2020	METANIUM	R/L HG R/ HG L XG R/XG L	BH-1	A	2016	STEPHANO	100XG/101XG	—	A
2015	METANIUM DC	R/L・HG R/L・XG R/L	BH-1	A	2020	BAYGAME	300PG/301PG	BH-2 BH-3 BH-4 BH-5	B
2018	BANTAM MGL	R/LPG R/PG L/HG R/HG L/XG R/XG L	BH-1	A			150/151	BH-1	B
2018	ALDEBARAN MGL	30/31/30HG/31HG	BH-1	A			150DH/151DH	BH-1	A
2016	ALDEBARAN BFS	R/L・XG R/L	BH-1	A	2020	GENPU XT	150/151	BH-1	A
2021	SCORPION DC	150/151/150HG/151HG/150XG/151XG	BH-1	A			200PG/201PG	BH-1	B
2021	SCORPION MD	300XG/301XG/300XGLH/301XGLH	BH-2 BH-3 BH-4 BH-5	A	2020	GENPU	200PG/201PG	BH-1	A
2019	SCORPION MGL	150/151/150HG/151HG/150XG/151XG	BH-1	A	2018	KOBUNE	800/1000/2000/3000	BH-3 BH-4 BH-5	—
2017	SCORPION BFS	R/L・XG R/L	BH-1	A			150/151	BH-1	B
2016	SCORPION	70/71/70HG/71HG/70XG/71XG	BH-1	A	2020	BARCETTA F CUSTOM	150DH/151DH	BH-1	A
2020	SLX DC	70/71/70HG/71HG/70XG/71XG	BH-1	A			150DHXG/151DHXG	BH-1	A
2019	SLX MGL	70/70HG/70XG 71/71HG/71XG	BH-1	A	2019	BARCETTA PREMIUM	150/151/150DH/151DH/150DH XG/151DH XG	BH-1	ダブル:A シングル:B
2021	SLX BFS	R/L・XG R/XG L	BH-1	A	2018	BARCETTA SC	800/1000/2000/3000	BH-3 BH-4 BH-5	B
2017	BASS ONE XT	R/L	BH-1	A	2018	BARCETTA	300PGDH/301PGDH	BH-1	A
2018	BASS RISE	BASE RISE/ BASE RISE (WITH LINE)	BH-1	A	2017	BARCETTA	200HGDH/201HGDH/300HGDH/301HGDH	BH-1	A
2020	EXSENCE DC SS	HG R/HG L/XG R/XG L	BH-1	A	2017	BARCETTA BB	300HG/301HG/300HGDH/301HGDH/300PGDH/301PGDH	BH-1	A
2017	EXSENCE DC	XG R/L	BH-1	A			600PG/600HG	BH-1	B
2014	BRENIUS	R/L	BH-1	A	2015	KAIKON	2000T/3000T/4000T	BH-4	B
2018	GRAPPLER PREMIUM	150XG/151XG	BH-1	B	2009	SPEEDMASTER 石鯛	2000T/3000T/4000T	BH-4	—
2019	GRAPPLER CT	150XG/151XG	BH-1	B	2020	SEIHAKOU LIMITED	R C 83 R/L	BH-1	A
2021	GRAPPLER	150HG/151HG	BH-1	A	2019	SEIHAKOU SP	RED RIGHT/RED LEFT/GOLD RIGHT/GOLD LEFT	BH-1	A
2017	GRAPPLER	300HG/301HG	BH-2 BH-3 BH-4 BH-5	B	2012	SEIHAKOU 60	BLUE/GOLD/SILVER	BH-1	A
2016	GRAPPLER BB	200HG/201HG	BH-1	A	2008	CHINUMATIC	1000SP/1001SP	BH-1	A
2019	ENGETSU CT	150HG/151HG/150PG/151PG	BH-1	A	2008		1000XT/1001XT・1000/1001	BH-1	—
2018	ENGETSU PREMIUM	150HG/150PG/151HG/151PG	BH-1	A	2020	BEASTMASTER	1000EJ	BH-2 BH-3 BH-4 BH-5 BH-6	B
2021	ENGETSU	100PG/101PG/100HG/101HG	BH-1	A			MD3000	BH-4 BH-5 BH-6	B
		150HG/151HG	BH-1	B	2019		2000EJ	BH-2 BH-3 BH-4 BH-5 BH-6	B
2017	ENGETSU BB	100HG/101HG	BH-1	A			6000/9000	BH-4 BH-5 BH-6	B
2016	SALTY ONE	100PG/101PG	BH-1	A	2018		2000	BH-2 BH-3 BH-4 BH-5 BH-6	B
2011	CALCUTTA CONQUEST DC	HGR/L・PG R/L	BH-1	A	2016		3000XP/3000XS	BH-4 BH-5 BH-6	B
2020	CALCUTTA CONQUEST BFS	100/101/100HG/101HG/200HG/201HG	BH-1	A	2014		6000/9000	BH-4 BH-5 BH-6	B
2021	CALCUTTA CONQUEST	100/101/200/201/100HG/101HG/200HG/201HG	BH-1	A	2021	FORCEMASTER	200	BH-1	B
2019	CALCUTTA CONQUEST	200DC/201DC	BH-1	A			200DH	BH-1	A
2018	CALCUTTA	300/301/400/401	BH-2 BH-3 BH-4 BH-5	A			1000	BH-2 BH-3 BH-4 BH-5 BH-6	B
2012		100/101/200/201	—	A			600/601	BH-2 BH-3 BH-4 BH-5	B
2013		300/301/400/401	—	A	2020		600DH/601DH	BH-2 BH-3 BH-4 BH-5	A
2020	OCEA CONQUEST LIMITED	200HG/201HG	BH-1	B			6000/9000	BH-4 BH-5 BH-6	B
2019	OCEA CONQUEST CT	200P G/201 P G	BH-1	A	2017		3000XP	BH-4 BH-5 BH-6	B
		300HG/301HG/300PG/301PG/400HG	BH-2 BH-4 BH-5	B	2016		1000/2000	BH-2 BH-3 BH-4 BH-5 BH-6	B
2016		200HG/201HG	BH-1	B	2015		800	BH-2 BH-3 BH-4 BH-5 BH-6	B
2015	OCEA CONQUEST	300PG/301PG	BH-2 BH-4 BH-5	B			3000	BH-4 BH-5 BH-6	B
2014		300HG/301HG	BH-2 BH-4 BH-5	B	2019	PLAYS	600	BH-2 BH-3 BH-4 BH-5	B
2015		200HG/201HG	BH-1	B	2018		3000XP	BH-4 BH-5	B
2015	OCEA CALCUTTA	200PG/201PG	BH-1	A	2017		4000	BH-4 BH-5	B
2013		300HG/301HG	BH-2 BH-3 BH-4 BH-5 BH-6	B	2016		800/1000	BH-3 BH-4 BH-5	B
2011		200PG/201PG/200HG	BH-1	A	2015	PLEMJO	3000	BH-4 BH-5	B
2020	OCEA JIGGER 4000	4000/4000HG	BH-2 (※2) BH-4 BH-5 BH-6	D					
2019	OCEA JIGGER FC	1000HG/1001HG/1500HG/1501HG	BH-2 BH-4 BH-5 BH-6	D					
		2000NRHG/2001NRHG/3000HG	BH-2 (※2) BH-4 BH-5 BH-6	D					
2017	OCEA JIGGER	1000HG/1001HG/1500HG/1501HG/1500PG/1501PG	BH-2 BH-4 BH-5 BH-6	B					
		2000NRHG/2001NRHG/2000NRPG/2001NRPG	BH-2 (※2) BH-4 BH-5 BH-6	D					
2020	TORIUM	1500HG	BH-2 BH-4 BH-5 BH-6	B					
		2000PG/2000HG	BH-2 (※2) BH-4 BH-5 BH-6	B					
2013	TALICA	20 II /25 II	—	B					
2012	CALCUTTA F	300F/301F/400F/401F	BH-1	A					
2013		800F/801F	BH-2 BH-3 BH-4 BH-5 BH-6	B					

※2 A SEPARATE WASHER (PART CODE <72116074900>) IS REQUIRED FOR INSTALLATION.

※YUMEYA PRODUCTS ARE LIMITED EDITION. PLEASE TAKE GOOD CARE OF THE ORIGINAL PARTS BEFORE CHANGING TO YUMEYA AS IN THE EVENT THAT THE YUMEYA PRODUCT CURRENTLY USED GETS DAMAGED OR LOST, THE ORIGINAL PART WILL HAVE TO BE RE-USED.

※THE YUMEYA SERIES COMPRISED OF COMPLETE ASSEMBLED PRODUCTS. THEREFORE PLEASE UNDERSTAND THAT THERE ARE CASES WHERE DAMAGED YUMEYA PARTS THAT CANNOT BE REPAIRED.

SHIMANO ORIGINAL BLANKS & PARTS



SPIRAL CORE

A FURTHER STRENGTHENED,
TOUGH FOUNDATION.

1.4X

INCREASE IN TORSIONAL STRENGTH

2.5X

INCREASE IN COMPRESSION STRENGTH



NEXT-GENERATION BASIC STRUCTURE, EVOLVED BY ADOPTING HIGH-STRENGTH MATERIALS.

Shimano pursues extreme strength, further strengthening in all directions such as bending, twisting, collapse, etc. by original design and manufacturing methods. Shimano's unique basic structure that enhances rod performance from the core, using carbon tape with high-strength resin achieved by Nano alloy technology in Spiral X. We achieved further strengthening with carefully selected materials. By comparison with the general structure, the torsion strength increased 1.4 times and the blank strength increased 2.5 times (compared with previous models). Furthermore, by comparison with spiral X, we achieved 10% increase in screw strength and 15% increase in crush strength.

EXCLUSIVE CONSTRUCTION OVERCOMES BLANK TWISTS AND ENHANCES ROD PERFORMANCE.

Spiral X construction consists of three layers: a blank made of vertical fibres, an inner layer and an outer layer both comprised of carbon tape that tightly winds the blank diagonally in opposite directions. By using this carbon tape in place of a conventional horizontal fibre sheet, Spiral X achieves enhanced torsional rigidity without adding extra weight.

This in turn facilitates instant power transmission for precise casting and fighting fish. Through its exclusive lightweight structure, Shimano's Spiral X construction enhances anglers' catching power.



REINFORCED CONSTRUCTION MAKES RODS TOUGHER AND ENSURES IT BENDS MORE ACCURATELY.

In Hi-Power X construction, the blank's outermost layer is diagonally wrapped with carbon tape, which forms an array of "X" shapes. The width of the tape, its winding angle and the part of the rod being wrapped are fine-tuned according to the target fish species.

The flexibility allows Shimano to adjust these wraps during construction for precise actions, enhanced overall strength and added twist resistance. In short, Hi-Power X construction delivers sharp and crisp rod control by the angler.



HIGHLY SENSITIVE NERVES IN THE REAR GRIP OF THE ROD.

High sensitivity coming from a hollow structure made from a mould. Rear grip has an important role to transfer subtle information coming from beneath the water.

Carbon monoque grip is a hollow structure so it is very light and can transfer even the smallest vibration to your hand.

BLANKS STRUCTURE / MATERIAL / DESIGN

FULL CARBON MONOCOQUE



The fundamentals of rod building is to maximise the potential of the blanks. On the rod is the reel seat, a crucial terminal communicating information back and forth between the angler above water and the fish under. Shimano has studied what anglers deem as a 'comfortable' gripping experience and shaped the abstract shape into creation.

CARBON SHELL GRIP



Using a hollowed structure made of carbon bound to the reel seat, the next-gen grip structure makes its entrance. Vibrations are now transmitted more clearly to anglers, resulting in a truly light yet highly sensitive grip.

NANOPITCH



With the Nanopitch, manufacturing method Shimano is able to wrap a molding tape which is used in the process of baking on a blank finely and with high precision. Because of the Nanopitch method blanks are tightened up to the extreme while at the same time more uniform pressure is applied, the circularity becomes higher and it contributes greatly to the overall rod strength.

DYNA BALANCE



Dyna Balance relies on a measurement system incorporated on rod actions and is designed to maximise the transmission of vibrations of the lure underwater to the rod. Through the detailed analysis of these measurements, rods with Dyna Balance offers a smooth natural bend.

UBD



UBD is a technique Shimano uses to choose the most suitable materials for each and every section (tip, belly and butt) of the rod. There are no parts in excess, forming the ideal action profile. UBD allows for a lower overall weight of rods without compromising strength and power. *Bass rods only

UBD MULTI-PIECE



By arranging the right material in the right place, the ultimate blanks design that brings weight reduction while maintaining strength and power is further increased, and only in the places where the basic and reinforced structures such as Spiral X Core and High Power X are effective. The multi-piece ultimate blanks design is a new structure that keeps the blanks even lighter while maintaining strength. *Bass rods only

CORE BLANKS

Achieving an improved resistance against twists and bends with the Spiral X Core. Parabola Tune creates a smooth bend which minimizes the stress and strain on joints of multi-piece rods. X Guides for optimal rod weight reduction. These three make up the Core Blanks tech and with the highest engineering precision, Shimano's ISO rods are strong, light and reliable!

SCREW LOCK JOINT



With a simple twist, sections are strongly and securely connected, increasing the joint strength of the rod while providing a worry free environment for fish fights.

ANTI LOCK JOINT



The Anti-Lock Joint system is a structure which adjusts the location of the stopper in the joint areas to prevent the joints from locking or being stuck when connected too tightly during setup.

BIOFIBRE



Biofibre construction has been renewed offering increased lifting power and excellent control of fighting fish hard close to the bank or boat.

TIP

TAFTEC ∞



An all new development - Taftec ∞ is three times more durable than the typical solid tips with an improved retrieving load by up to 5 times!



TAFTEC α



A solid tip that achieves supple and delicate bending while maintaining strength without reducing the diameter of the tip.



SOFTUBE TOP



Softube Top provides the sensitivity of an ultra fine solid carbon tip with the lightness of a hollow construction.



HIGH RESPONSE SOLID

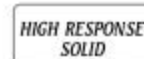

Highly elastic solid tip in pursuit of the perfect action. Even with small and light lures, the supple and elastic tip can instantaneously set the hook (quick response). Suitable for aggressive and assertive fishing styles!

HI-POWER X TIP



A solid tip that achieves supple and delicate bending while maintaining strength without reducing the diameter of the tip.



HI-POWER X SOLID



Enforcing the supple solid tip with carbon tape helps to minimize any power loss or play in the operation of the rod, still giving a natural bend. X Solid Power significantly improves the castability and sensitivity of the rod.



REEL SEAT / GRIP

CI4/CI4+



SHIMANO develop a wide range of reel seat designs to match the rod on which they are applied. Some of the more specialised reel seats incorporate the use of CI4 and CI4+ carbon. CI4 is over 20% lighter and 1.6 times stronger than conventional polymers, with CI4+ being a technical advancement of CI4 which offers even more strength. This exclusive material allows SHIMANO to make ultra light reel seats, whilst maintaining the maximum strength

PERFECTION SEAT XT

On top of improved grip comfort and power transmission from user to rod, the perfection seat XT significantly reduces the weight of the reel seat. A combination of both delicate action and comfort is made possible by optimizing the thickness reel seat shell. *Carbon-reinforced CI4+ material



FULL HOLDING SEAT

Whether it's gripping fully, palming, with 2-4 fingers or any kind of holding method, the Full Holding Seat has got you covered. The seat sits perfectly in your hands, supporting you in your power fights against strong tough fish. *Available on lure rods



X-SEAT



The fundamentals of rod building is to maximise the potential of the blanks. On the rod is the reel seat, a crucial terminal communicating information back and forth between the angler above water and the fish under. Shimano has studied what anglers deem as a 'comfortable' gripping experience and shaped the abstract shape into creation.



SALTWATER RODS



GRAPPLER

Tested over and over again throughout the seas across the entire globe, the Grappler rod which anglers have been waiting anxiously for, has finally been developed. The lineup is branched into 4 categories namely Jigging, Slow Jigging, Light Jigging and Popping. The rod is equipped with the most high end double X technology - Hi Power X and Spiral X which gives the rod its light weight and high resistance to torsional load applied on the rod. The Grappler series is a global standard rod which always leaves control to the anglers and never to the monsters.



※1 : Type LJ

Type J NEW JIGGING

Model Number	Rod Length [m]	No. of Sections	Transport Length (cm)	Lure Weight [g]	Line Weight [PE]	Type
S60-2	1.83	2	130.7	MAX160	MAX2.5	SPINNING
S60-3	1.83	2	130.7	MAX180	MAX3	SPINNING
S60-4	1.83	2	130.2	MAX210	MAX4	SPINNING
S60-5	1.83	2	129.7	MAX250	MAX5	SPINNING
S56-6	1.68	2	112.0	MAX300	MAX6	SPINNING
S56-7	1.68	2	111.5	MAX350	MAX8	SPINNING
S53-8	1.60	2	104.0	MAX400	MAX8	SPINNING
B60-2	1.83	2	138.9	MAX160	MAX2.5	BAITCAST
B60-3	1.83	2	138.9	MAX180	MAX3	BAITCAST
B60-4	1.83	2	137.9	MAX210	MAX4	BAITCAST
B60-5	1.83	2	136.9	MAX250	MAX5	BAITCAST
B56-6	1.68	2	103.3	MAX300	MAX6	BAITCAST
B56-7	1.68	2	102.8	MAX350	MAX8	BAITCAST
B53-8	1.60	2	95.3	MAX400	MAX8	BAITCAST
GRAPPLER TYPE J (3-PIECE MODEL)						
S60-3/3	1.83	3	69.0	MAX180	MAX3	SPINNING
S60-4/3	1.83	3	68.8	MAX210	MAX4	SPINNING
S60-5/3	1.83	3	68.5	MAX250	MAX5	SPINNING
B60-3/3	1.83	3	73.3	MAX180	MAX3	BAITCAST
B60-4/3	1.83	3	73.8	MAX210	MAX4	BAITCAST
B60-5/3	1.83	3	73.8	MAX250	MAX5	BAITCAST

Type LJ — LIGHT JIGGING/ SUPER LIGHT JIGGING (0 POWER)

Model Number	Rod Length [m]	No. of Sections	Transport Length (cm)	Lure Weight [g]	Line Weight [PE]	Type
S66-0	1.98	2	158.3	20-100	MAX1.2	SPINNING
S63-1	1.91	2	146.1	30-130	MAX1.5	SPINNING
S63-2	1.91	2	146.1	40-160	MAX2	SPINNING
S63-3	1.91	2	143.6	50-180	MAX2	SPINNING
B66-0	1.98	2	151.3	30-100	MAX1.2	BAITCAST
B63-1	1.91	2	144.0	40-130	MAX1.5	BAITCAST
B63-2	1.91	2	144.0	50-160	MAX2	BAITCAST
B63-3	1.91	2	144.0	60-180	MAX2	BAITCAST

Type Slow J — SLOW JIGGING

Model Number	Rod Length [m]	No. of Sections	Transport Length (cm)	Lure Weight [g]	Line Weight [PE]	Type
B68-1	2.03	2	156.2	MAX160	MAX1.5	BAITCAST
B68-2	2.03	2	156.2	MAX200	MAX2	BAITCAST
B68-3	2.03	2	156.2	MAX260	MAX2.5	BAITCAST
B68-4	2.03	2	156.2	MAX330	MAX3	BAITCAST
B68-5	2.03	2	156.2	MAX400	MAX3	BAITCAST

Type C NEW CASTING

Model Number	Rod Length [m]	No. of Sections	Transport Length (cm)	Lure Weight [g]	Line Weight [PE]	Type
S70L	2.13	2	167.7	MAX60	MAX2.5	SPINNING
S73ML	2.21	2	169.6	MAX80	MAX3	SPINNING
S710ML	2.39	2	182.2	MAX80	MAX4	SPINNING
S77M	2.31	2	174.2	MAX100	MAX5	SPINNING
S80M	2.44	2	182.9	MAX100	MAX5	SPINNING
S77MH	2.31	2	169.9	MAX120	MAX6	SPINNING
S82MH	2.49	2	181.9	MAX120	MAX6	SPINNING
S82H	2.49	2	181.9	MAX150	MAX8	SPINNING
S82XH	2.49	2	181.9	MAX180	MAX10	SPINNING
GRAPPLER TYPE C (3-PIECE MODEL)						
S80M-3	2.44	3	87.5	MAX100	MAX5	SPINNING
S82MH-3	2.49	3	89.0	MAX120	MAX6	SPINNING
S82H-3	2.49	3	89.0	MAX150	MAX8	SPINNING
S82XH-3	2.49	3	89.0	MAX180	MAX10	SPINNING





GRAPPLER BB TYPE J S60-4

GRAPPLER BB TYPE J B60-4

GRAPPLER BB TYPE J B56-6

GRAPPLER BB TYPE LJ S63-2

GRAPPLER BB TYPE LJ B63-2

GRAPPLER BB TYPE SLOWJ B66-3

GRAPPLER BB NEW

Covering all areas of jigging with 22 items in the lineup. A 'global' rod catering to the whole world.

The Grappler BB is a rod you can bring across the whole world. With high cost performance, the Hi-Power X blanks eliminates any discomfort resulting from high twisting loads. This is crucial in off shore games as both power and response is improved, even when applying aggressive jigging styles or fighting larger species. Since the Grappler BB is a global rod, Shimano wanted to make it as convenient to carry around as possible, resulting in all 22 items being 2-piece rods, with a bend profile almost similar to 1-piece rods. Whether it's speed and power for jigging, or versatility in in-shore games, or the charming slow jigging which uses slow and fall actions, there is without a doubt a model for you in the Grappler BB lineup.

Type J ————— JIGGING

Model Number	Rod Length [m]	No. of Sections	Transport Length (cm)	Lure Weight [g]	Line Weight [PE]	Type
S60-2	1.83	2	131.6	MAX160	MAX2.5	SPINNING
S60-3	1.83	2	132.6	MAX180	MAX3	SPINNING
S60-4	1.83	2	132.1	MAX210	MAX4	SPINNING
S60-5	1.83	2	129.7	MAX250	MAX5	SPINNING
S56-6	1.68	2	114.1	MAX300	MAX6	SPINNING
B60-2	1.83	2	139.8	MAX160	MAX2.5	BAITCAST
B60-3	1.83	2	140.8	MAX180	MAX3	BAITCAST
B60-4	1.83	2	140.0	MAX210	MAX4	BAITCAST
B60-5	1.83	2	138.8	MAX250	MAX5	BAITCAST
B56-6	1.68	2	105.7	MAX300	MAX6	BAITCAST

Type LJ ————— LIGHT JIGGING/ SUPER LIGHT JIGGING (0 POWER)

Model Number	Rod Length [m]	No. of Sections	Transport Length (cm)	Lure Weight [g]	Line Weight [PE]	Type
S66-0	1.98	2	159.3	20-100	MAX1.2	SPINNING
S63-1	1.91	2	147.2	30-130	MAX1.5	SPINNING
S63-2	1.91	2	147.4	40-160	MAX2	SPINNING
S63-3	1.91	2	145.6	50-180	MAX2	SPINNING
B66-0	1.98	2	152.3	30-100	MAX1.2	BAITCAST
B63-1	1.91	2	145.2	40-130	MAX1.5	BAITCAST
B63-2	1.91	2	145.4	50-160	MAX2	BAITCAST
B63-3	1.91	2	145.6	60-200	MAX2	BAITCAST

Type Slow J ————— SLOW JIGGING

Model Number	Rod Length [m]	No. of Sections	Transport Length (cm)	Lure Weight [g]	Line Weight [PE]	Type
B66-1	1.98	2	150.2	MAX160	MAX1.5	BAITCAST
B66-2	1.98	2	150.2	MAX200	MAX2	BAITCAST
B66-3	1.98	2	150.2	MAX260	MAX2.5	BAITCAST
B66-4	1.98	2	150.2	MAX330	MAX3	BAITCAST



REEL TECHNOLOGY

JIG SPINNING REELS

EXPORT SPINNING REELS

BAITCAST REELS

SW OVERHEAD REELS

ELECTRIC REELS

YUMENA/ GLOSSARY

ROD TECHNOLOGY

SALTWATER RODS

BOAT RODS

BASS RODS

SPECIAL RODS

LIFESTYLE GEAR



OCEA JIGGER CONCEPT S NEW

Giving off a sense of speedy operability during jigging is the new spinning rod, Ocea Jigger Concept S. The rod is lightweight and packed with power and balance for an enjoyable and stress-free spinning jigging experience. In order to materialize the concept of stress-free, the key goals were Slim, Smooth, Strong. Equipped with Spiral X technology, the slender and light rod is made with a highly recoiling blank. Regardless of the strength of the backbone of the rod, the smooth bend or curvature of the rod plays a role in reducing the load and fatigue of anglers.

Model Number	Rod Length [m]	No. of Sections	Transport Length (cm)	Lure Weight [g]	Line Weight [PE]	Type
S64-1	1.93	1	193.0	60-150	MAX2.5	SPINNING
S64-2	1.93	1	193.0	80-160	MAX2.5	SPINNING
S67-2	2.01	1	201.0	80-160	MAX2.5	SPINNING
S62-3	1.88	1	188.0	90-180	MAX3	SPINNING
S66-3	1.98	1	198.0	90-180	MAX3	SPINNING
S62-4	1.88	1	188.0	100-210	MAX4	SPINNING
S66-4	1.98	1	198.0	100-210	MAX4	SPINNING
S60-5	1.83	1	183.0	120-250	MAX5	SPINNING



OCEA JIGGER

Ocea Jigger (Spinning)

Shimano OCEA series - This name is well known to the angling field for its powerful, reliable and long lasting performance. With that in mind Shimano's engineers came out with the OCEA JIGGER rods which is what all anglers demand, an excellent built jigging rod. The blanks are made with our Spiral X process and reinforced through Hi-Power X. All rods come standard with Fuji Titanium SiC guides.

Model Number	Rod Length [m]	No. of Sections	Transport Length (cm)	Lure Weight [g]	Line Weight [PE]	Type
NATURAL JERK						
S641	1.93	1	193.0	50-160	MAX2.5	SPINNING
S642	1.93	1	193.0	60-180	MAX2.5	SPINNING
S643	1.93	1	193.0	80-200	MAX3	SPINNING
S644	1.93	1	193.0	100-240	MAX4	SPINNING
QUICK JERK						
S621	1.88	1	188.0	60-150	MAX2.5	SPINNING
S622	1.88	1	188.0	80-160	MAX2.5	SPINNING
S623	1.88	1	188.0	90-180	MAX3	SPINNING
S624	1.88	1	188.0	100-210	MAX4	SPINNING
S605	1.83	1	183.0	120-150	MAX3	SPINNING
QUICK JERK [SHORT LENGTH MODEL]						
S510-3	1.78	1	178.0	100-180	MAX3	SPINNING
S510-4	1.78	1	178.0	120-210	MAX4	SPINNING
S510-5	1.78	1	178.0	140-250	MAX5	SPINNING
S58-6	1.73	1	173.0	160-300	MAX6	SPINNING

Ocea Jigger (Baitcast)

The constant pursue of power resulted in the brand new Ocea Jigger Baitcast series. Experience a whole new level of responsiveness that allows easy manipulation of the jig with a quick jerk through the use of a high-dimensional blank while reducing an anglers' burden. With the use of Shimano's latest Spiral X Core, rod's rigidity and strength has been greatly improved in turn eliminating unnecessary power loss.

Model Number	Rod Length [m]	No. of Sections	Transport Length (cm)	Lure Weight [g]	Line Weight [PE]	Type
B60-3	1.83	1	183.0	80-180	MAX3	BAITCAST
B60-4	1.83	1	183.0	100-220	MAX4	BAITCAST
B60-5	1.83	1	183.0	120-300	MAX5	BAITCAST



※1: SHORT LENGTH MODEL



OCEA JIGGER ∞ B65-3

OCEA JIGGER ∞ MOTIVE B610-4

OCEA JIGGER LJ B63-2

OCEA JIGGER LJ S65-0/FS

OCEA JIGGER

The essence of a jigging rod lies in its operability when it comes to jerking the rod (repeated action of lifting and lowering the tip of the rod quickly). The OCEA Jigger Infinity lineup uses full 1-piece blanks which are slender and finished with a slow taper. To those who wish to challenge the monsters in uncharted waters, the addition of these 5 reliable rods with power ratings 6 to 10 will keep you company through and through. Jump into the new realm of Slow Jigging with the OCEA Jigger Infinity!

Model Number	Rod Length [m]	No. of Sections	Transport Length (cm)	Lure Weight [g]	Line Weight [PE]	Type
B65-0	1.96	1	196.0	40-130	MAX1.5	BAITCAST
B65-1	1.96	1	196.0	80-180	MAX1.5	BAITCAST
B65-2	1.96	1	196.0	100-230	MAX2	BAITCAST
B65-3	1.96	1	196.0	120-280	MAX2.5	BAITCAST
B63-4	1.91	1	191.0	140-350	MAX3	BAITCAST
B63-5	1.91	1	191.0	160-430	MAX3	BAITCAST
B63-6	1.91	1	191.0	180-500	MAX4	BAITCAST
B61-7	1.85	1	185.0	200-600	MAX4	BAITCAST
B61-8	1.85	1	185.0	230-750	MAX4	BAITCAST
B61-9	1.85	1	185.0	260-900	MAX5	BAITCAST
B61-10	1.85	1	185.0	300-1200	MAX5	BAITCAST



*1 :Excluding B61-9, B61-10

OCEA JIGGER MOTIVE

Feel the jig with your fingertips as you manipulate it and achieve fascinating long-fall action so attractive that no fish can resist. Semi-long 6'10" blanks eliminate power loss and enhance sensitivity with Shimano's latest rod technology: Spiral X Core. Skillfully shift between slow to medium pitch jerks of variable speeds to control the long-fall action as you please. With the newest Full Holding Seat, comfort is maximised for stress-free jigging all day.

Model Number	Rod Length [m]	No. of Sections	Transport Length (cm)	Lure Weight [g]	Line Weight [PE]	Type
B610-0	2.08	2	161.4	40-130	MAX1.5	BAITCAST
B610-1	2.08	2	161.1	80-180	MAX1.5	BAITCAST
B610-2	2.08	2	160.8	100-230	MAX2	BAITCAST
B610-2+	2.08	2	161.1	110-270	MAX2.5	BAITCAST
B610-3	2.08	2	161.2	130-300	MAX2.5	BAITCAST
B610-4	2.08	2	161.2	160-380	MAX3	BAITCAST
B610-5	2.08	2	161.2	200-450	MAX3	BAITCAST
B610-6	2.08	2	161.9	230-500	MAX4	BAITCAST



OCEA JIGGER LJ

A model that pursues the essence of light jigging with fine bending along the whole blank. This is the flagship model of light jigging rods. Furthermore, the light and strong Spiral X Core blank strengthens the whole body and enables the rod to flex like a spring from the tip to the end. Ocea Jigger LJ is a full one piece structure right through to the grip.

	Model Number	Rod Length [m]	No. of Sections	Transport Length (cm)	Lure Weight [g]	Line Weight [PE]	Type
Full Solid Super Light Jigging	S65-0/ FS	1.96	1	196.2	20-100	MAX1.2	SPINNING
	B65-0/ FS	1.96	1	196.2	30-100	MAX1.2	BAITCAST
Full Solid	S62-1/ FS	1.88	1	188.0	30-130	MAX1.5	SPINNING
	S62-2/ FS	1.88	1	188.0	40-160	MAX2	SPINNING
	B62-1/ FS	1.88	1	188.2	40-130	MAX1.5	BAITCAST
	B62-2/ FS	1.88	1	188.2	50-160	MAX2	BAITCAST
Standard	B63-1	1.91	1	191.0	40-130	MAX1.5	BAITCAST
	B63-2	1.91	1	191.0	50-160	MAX2	BAITCAST
	B63-3	1.91	1	191.0	60-200	MAX2	BAITCAST
	B61-1HP	1.86	1	186.0	40-130	MAX1.5	BAITCAST
	B61-2HP	1.86	1	186.0	50-160	MAX2	BAITCAST



*1 : Excluding Full Solid series *2 : Full Solid Series

REEL TECHNOLOGY
JIM SPINNING REELS
EXPORT SPINNING REELS
BAITCAST REELS
SW OVERHEAD REELS
ELECTRIC REELS
YUMENA/ GLOSSARY
ROD TECHNOLOGY
SALTWATER RODS
BOAT RODS
BASS RODS
SPECIAL RODS
LIFESTYLE GEAR



GAME Type Lj NEW

The new Game Type Lj line up is now more comprehensive to cover all the different jigging applications for jig up to 180g. The oversize EVA handle also allows maximum range of motion for flicking action of the jig. Lighter tip action gives maximum control over light jigs and the Spiral X Core and Hi-Power X blanks gives an extra backbone so that maximum pressure can be applied onto the fish at the end of the line.

	Model Type	Length [m]	No. of Sections	Transport Length [cm]	Jig Weight (g)	Line Rating [PE]	Type
Full Solid Super Light Jigging	S65-00/FS	1.96	2	154.5	10-80	MAX1	SPINNING
	S65-0/FS	1.96	2	154.0	20-100	MAX1.2	SPINNING
	B65-0/FS	1.96	2	149.8	30-100	MAX1.2	BAITCAST
Full Solid	B62-1/FS	1.88	2	141.8	40-130	MAX1.5	BAITCAST
	B62-2/FS	1.88	2	141.8	50-160	MAX2	BAITCAST
Standard	S63-1	1.91	2	145.0	30-130	MAX1.5	SPINNING
	S63-2	1.91	2	145.0	40-160	MAX2	SPINNING
	B63-1	1.91	2	145.8	40-130	MAX1.5	BAITCAST
	B63-2	1.91	2	145.8	50-160	MAX2	BAITCAST
	B63-3	1.91	2	145.8	60-180	MAX2	BAITCAST



※1 : EXCLUDING FULL SOLID SERIES ※2 : FULL SOLID SERIES

GAME Type J NEW

Jerk, Power & Stress Free! Evolved form of the absolute fundamentals!

This impressive new series feature improved blank technology and offer five spin and two overhead's ranging from PE2.5 to PE8 line ratings. Improving on the original 2015 series, the 2020 series features Hi-Power X and now Shimano's patented Spiral X Core carbon construction to reduce weight and increase strength.

Model Type	Length [m]	No. of Sections	Transport Length [cm]	Jig Weight (g)	Line Rating [PE]	Type
S64-1	1.93	2	143.1	MAX 150	MAX 2.5	SPINNING
S64-2	1.93	2	142.6	MAX 160	MAX 2.5	SPINNING
S60-3	1.83	2	134.1	MAX 180	MAX 3	SPINNING
S64-3	1.93	2	143.1	MAX 180	MAX 3	SPINNING
S510-4	1.78	2	128.1	MAX 210	MAX 4	SPINNING
S62-4	1.88	2	138.1	MAX 210	MAX 4	SPINNING
S510-5	1.78	2	127.6	MAX 250	MAX 5	SPINNING
S56-6	1.68	2	114.1	MAX 300	MAX 6	SPINNING
S56-7	1.68	2	113.6	MAX 350	MAX 8	SPINNING
S53-8	1.60	2	105.5	MAX 400	MAX 8	SPINNING
B60-2	1.83	2	140.4	MAX 160	MAX 2.5	BAITCAST
B60-3	1.83	2	141.4	MAX 180	MAX 3	BAITCAST
B60-4	1.83	2	140.4	MAX 210	MAX 4	BAITCAST
B60-5	1.83	2	139.4	MAX 250	MAX 5	BAITCAST
B56-6	1.68	2	105.3	MAX 300	MAX 6	BAITCAST
B56-7	1.68	2	104.8	MAX 350	MAX 8	BAITCAST
B53-8	1.60	2	96.8	MAX 400	MAX 8	BAITCAST



※1 : EXCLUDING 6~8 POWER

GAME Type Slow J NEW

The strength and bend of this latest Game Type SJ model closely mimics that of a one-piece rod because of the grip joint. Revolving around the fall action centered slow jig style, use all sorts of combination between fast and slow jerks, low and high pitch to control the speed and actions of the jigs.

Model Type	Length [m]	No. of Sections	Transport Length [cm]	Jig Weight (g)	Line Rating [PE]	Type
B66-0	1.98	2	150.2	MAX 130	MAX 1.5	BAITCAST
B66-1	1.98	2	150.2	MAX 160	MAX 1.5	BAITCAST
B66-2	1.98	2	150.2	MAX 200	MAX 2	BAITCAST
B66-3	1.98	2	150.2	MAX 260	MAX 2.5	BAITCAST
B66-4	1.98	2	150.2	MAX 330	MAX 3	BAITCAST
B66-5	1.98	2	150.2	MAX 400	MAX 3	BAITCAST
B66-6	1.98	2	150.2	MAX 500	MAX 4	BAITCAST





EGING S86ML

SHORE JIGGING S100MH

AJING S64UL-S

LIGHT JIGGING S63ML

SALTY ADVANCE

A range of rods for anglers looking to begin exploring the saltwater game!

With blanks similar to those of the BB series rods, the rods in this range are light, sharp and powerful. Unlike its predecessors, the second generation of Salty Advance rods use All K Guides to minimise troubles occurring from lines. As each and every rod in this range has been designed for specific targets, anglers are able to choose easily which rods to get depending on the target species.

LIGHT JIGGING

Pair with light tackle which reduces fatigue

AJING

Suitable for pairing with lure weighing from range MAX6 TO MAX12

EGING

Specializes in the sharp action of Egi that is effective in fighting against squid.

SHORE JIGGING

Suitable for pairing with metal jigs and heavy plugs.

Model Number	Rod Length [m]	No. of Sections	Closed Length (cm)	Lure Weight [g]/ [No.]	Line Weight [PE]	Type
LIGHT JIGGING						
B63ML	1.91	2	142.5	MAX160	MAX2	BAITCAST
S63ML	1.91	2	146.5	MAX160	MAX2	SPINNING
EGING						
S83ML	2.52	2	129.4	1.8-3.8	0.4-1	SPINNING
S86ML	2.59	2	133.2	1.8-3.8	0.4-1	SPINNING
S83M	2.52	2	129.4	2-4	0.5-1	SPINNING
S86M	2.59	2	133.2	2-4	0.5-1	SPINNING
AJING						
S64UL-S	1.93	2	99.0	0.3-6	0.1-0.4	SPINNING
S610L-S	2.08	2	106.5	0.5-12	0.1-0.6	SPINNING
SHORE JIGGING						
S96M	2.90	2	149.5	MAX60	MAX2	SPINNING
S100M	3.05	2	157.0	MAX60	MAX2	SPINNING
S96MH	2.90	2	149.5	MAX80	MAX3	SPINNING
S100MH	3.05	2	157.0	MAX80	MAX3	SPINNING
S100H	3.05	2	157.0	MAX100	MAX4	SPINNING



※1 : S64UL-S
 ※2 : S610L-S

REEL TECHNOLOGY

JDM SPINNING REELS

EXPORT SPINNING REELS

BAITCAST REELS

SW OVERHEAD REELS

ELECTRIC REELS

YUMEXA/ GLOSSARY

ROD TECHNOLOGY

SALTWATER RODS

BOAT RODS

BASS RODS

SPECIAL RODS

LIFESTYLE GEAR

SpeedMaster

The SpeedMaster Saltwater series is our most complete offshore rod to be launched. Featuring 13 distinct SKUs, we have cover almost all the different saltwater applications that modern day anglers would require. With sensitive tips, combined with extreme power the SpeedMaster will control any wild charging pelagic in double quick time, bringing it back to shore with ease. All SpeedMaster models feature Fuji K guides for unbeatable casting performance and ergonomic EVA handle to enhance user experience. A must have rod for any sea going anglers!

Model Number	Rod Length [ft]	No. of Sections	Lure Weight [g]	Line Weight [PE]	Type
JIGGING					
S603	6'	2	60-160	MAX3	SPINNING
S604	6'	2	90-200	MAX4	SPINNING
S605	6'	2	110-240	MAX5	SPINNING
B633	6'3"	2	75-160	MAX3	BAITCAST
B634	6'	2	90-200	MAX4	BAITCAST
CASTING					
S68L	6'8"	2	10-45	MAX2	SPINNING
S73ML	7'3"	2	15-60	MAX3	SPINNING
S76M	7'6"	2	25-80	MAX4	SPINNING
S1000MH	10'	2	80-100	MAX4	SPINNING
SLOW JIGGING					
B566	5'6"	1	180-600	MAX3	BAITCAST
B634	6'3"	1	150-450	MAX2	BAITCAST
B684	6'8"	1	150-250	MAX2	BAITCAST
B685	6'8"	1	180-300	MAX2.5	BAITCAST

SpeedMaster®

No frills, all thrills SW rod series for any situation!

If you are looking for a true SW workhorse, this series is it! There are 11 SKUs in this series and every one of them is a serious workhorse, capable of jigging, bottom fishing and even light casting! We use highly durable Fuji MN guides for the versatile jig models while lightweight Fuji Y guides for the light jig series. Finished off with a premium aggressive styling, this is one SW rod that all anglers should have!

Now with 2 specific Shore Egi Models - S803 & S806!

Model Number	Rod Length [ft]	No. of Sections	Lure Weight [g]	Line Weight [lb]	Type
JIGGING					
S603	6'0"	2	MAX180	MAX3	Spinning
S584	5'8"	2	MAX210	MAX4	Spinning
S565	5'6"	2	MAX250	MAX5	Spinning
B603	6'0"	2	MAX180	MAX3	Baitcast
B584	5'8"	2	MAX210	MAX4	Baitcast
LIGHT JIGGING					
S631	6'3"	2	MAX120	MAX1.5	Spinning
S632	6'3"	2	MAX150	MAX2	Spinning
B631	6'3"	2	MAX120	MAX1.5	Baitcast
B632	6'3"	2	MAX150	MAX2	Baitcast
EGING					
S803	8'3"	2	2.5-3.5	0.6-15	Spinning
S806	8'6"	2	2.5-3.5	0.6-15	Spinning





EXAGE BOTTOMSHIP



EXAGE BOTTOMSHIP

EXAGE *Bottomship*

This is a versatile saltwater rod with very attractive customised styling, using high quality kevlar material and cross carbon taping. The EVA grip is also ergonomic for comfortable fishing.

Model Number	Rod Length [ft]	No. of Sections	Lure Weight [g]	Line Weight [PE]	Type
S603	6'	2	MAX150	1-3	SPINNING
S584	5'8"	2	MAX180	2-4	SPINNING
S566	5'6"	2	MAX250	4-6	SPINNING
B633	6'3"	2	MAX150	1-3	BAITCAST
B634	6'3"	2	MAX180	2-4	BAITCAST



BEASTMASTER DX

BeastMaster DX

An entry level saltwater jiggging rod, the BeastMaster is made with renewed action to suit modern day jiggging. With enhanced cosmetics, this rod has great appeal and is also fitted with Fuji guides as well as Sea guide reel seat.

Model Number	Rod Length [ft]	No. of Sections	Lure Weight [g]	Line Weight [PE]	Type
JIGGING					
S603	6'	2	MAX150	3	SPINNING
S584	5'8"	2	MAX200	4	SPINNING
S625	6'2"	2	MAX300	5	SPINNING
B633	6'3"	2	MAX150	3	BAITCAST
B604	6'	2	MAX200	4	BAITCAST
B566	5'6"	2	MAX350	6	BAITCAST
SLOW JIGGING					
B684	6'8"	2	150-250	2	BAITCAST
B634	6'3"	2	90-200	4	BAITCAST



MoonShot S96M

MOONSHOT **NEW**

Low on price does not mean low on features. The new Moonshot is a rod that punches above its weight. Dynamic Shimano "High Power X" process creates a strong and durable rod. Equipped with Fuji SiC K type guides and Shimano original reel seat, this is a rod catered to anglers of all level.

Model Number	Rod Length [m]	No. of Sections	Closed Length [cm]	Lure Weight [g]	Line Weight [PE]	Type
S90L	2.75	2	141.1	MAX28	0.4-1.2	SPINNING
S86ML	2.59	2	133.4	MAX38	0.6-1.5	SPINNING
S90ML	2.75	2	141.1	MAX38	0.6-1.5	SPINNING
S96ML	2.90	2	148.7	MAX38	0.6-1.5	SPINNING
S100ML	3.05	2	156.0	MAX38	0.6-1.5	SPINNING
S96M	2.90	2	148.7	MAX50	0.8-2	SPINNING
S100M	3.05	2	156.0	MAX50	0.8-2	SPINNING
S106M	3.20	2	163.6	MAX50	0.8-2	SPINNING
S110M	3.35	2	172.1	MAX50	0.8-2	SPINNING
S96MH	2.90	2	148.7	MAX60	1-2.5	SPINNING
S100MH	3.05	2	156.0	MAX60	1-2.5	SPINNING
S106MH	3.20	2	163.6	MAX60	1-2.5	SPINNING





OCEA PLUGGER LIMITED S83H

OCEA PLUGGER BG BLUEFIN TUNA S7000XH

OCEA PLUGGER FLEX LIMITED S83MH

OCEA PLUGGER FULL THROTTLE S88H

OCEA PLUGGER LIMITED NEW

When it comes to off-shore casting games, nothing is more desirable than casting distance. The OCEA Pluggger Limited focuses on just that - a rod to send jigs and lures soaring through the sky and getting that extra few meters of distance in.

Model Number	Rod Length [m]	No. of Sections	Closed Length (cm)	Lure Weight [g]	Line Weight [PE]	Type
S83M	2.53	2	185.5	MAX100	MAX5	SPINNING
S83MH	2.53	2	185.3	MAX120	MAX6	SPINNING
S710H	2.40	2	172.3	MAX150	MAX8	SPINNING
S83H	2.53	2	185.0	MAX150	MAX8	SPINNING
S88H	2.64	2	185.6	MAX150	MAX8	SPINNING
S82XH	2.50	2	182.4	MAX180	MAX10	SPINNING



OCEA PLUGGER BG

Ocea Pluggger Popping series is for the professional anglers looking for the best popping rods. The series encompass power and workability, ensuring that angler fatigue can be properly managed throughout the fishing trip. All rods are exquisitely made with Shimano Spiral X and super reinforced with Shimano High Power X finish. To suit different type of popping there are 3 main series to choose from; Wild Response, Monster Drive and Flex for monster GT fishing to Tuna Fishing.

Model Number	Rod Length [m]	No. of Sections	Transport Length (cm)	Lure Weight [g]	Line Weight [PE]	Type
MONSTER DRIVE						
S86H-3	2.59	3	97.0	MAX180	MAX8	SPINNING
S83XH-3	2.51	3	94.5	MAX200	MAX10	SPINNING
FLEX ENERGY						
S83H	2.51	2	179.1	MAX180	MAX8	SPINNING
S710XH	2.39	2	166.1	MAX200	MAX10	SPINNING
BLUEFIN TUNA						
S730XH	2.22	2	148.6	MAX250	MAX12	SPINNING
S7000XH	2.13	2	140.6	MAX250	MAX12	SPINNING



OCEA PLUGGER FLEX LIMITED

Ocea Pluggger rods combine both Spiral X and Hi-Power X construction features into the blank. Spiral X construction consists of three layers: a blank made of vertical fibers, an inner layer, and an outer layer both comprised of carbon tape that tightly winds the blank diagonally in opposite directions. This in turn facilitates instant power transmission for precise casting and fighting fish.

Model Number	Rod Length [m]	No. of Sections	Closed Length (cm)	Lure Weight [g]	Line Weight [PE]	Type
S80L	2.44	2	183.2	MAX50	MAX2.5	SPINNING
S710ML	2.39	2	178.2	MAX60	MAX3	SPINNING
S80M	2.44	2	180.2	MAX80	MAX4	SPINNING
S86M	2.59	2	191.8	MAX90	MAX4	SPINNING
S83MH	2.52	2	184.4	MAX110	MAX5	SPINNING
S83H	2.52	2	184.4	MAX130	MAX6	SPINNING



OCEA PLUGGER FULL THROTTLE

Model Number	Rod Length [m]	No. of Sections	Transport Length (cm)	Lure Weight [g]	Line Weight [PE]	Type
S74ML	2.23	2	172.1	20-70	MAX4	SPINNING
S77M	2.31	2	174.3	30-90	MAX5	SPINNING
S80M	2.43	2	182.7	30-100	MAX5	SPINNING
S82MH	2.48	2	181.9	45-120	MAX6	SPINNING
S83H	2.51	2	184.6	60-150	MAX8	SPINNING
S88H	2.64	2	195.1	60-150	MAX8	SPINNING



COLTSNIPER XTUNE

When fishing for large contenders from the shore, it is absolutely understandable why anglers would want a rod which guarantees performance. Introducing the latest COLTSNIPER XTUNE with a unbelievably reliable blank which is highly resistant to twisting loads. The Screw Lock Joint feature also increases the grip strength at the joint of the rod!

Model Number	Rod Length [m]	No. of Sections	Closed Length (cm)	Lure Weight [g]	Line Weight [PE]	Type
S100M	3.05	2	157.0	MAX50	MAX3	SPINNING
S100MH	3.05	2	157.0	MAX70	MAX4	SPINNING
S106MH/PS	3.20	2	164.5	MAX70	MAX4	SPINNING
S100H	3.05	2	157.0	MAX100	MAX5	SPINNING
S106H/PS	3.20	2	164.5	MAX100	MAX5	SPINNING
S100XH	3.05	2	157.0	MAX120	MAX6	SPINNING
S106XH/PS	3.20	2	164.5	MAX120	MAX6	SPINNING
S98XXH	2.95	2	152.0	MAX150	MAX8	SPINNING



COLTSNIPER XR

The COLTSNIPER XR series provides balance in sharpness, power, long casting abilities and lightness, making it the perfect partner when it comes to shore jigging and plugging games. In addition to strengthening the blanks with Spiral X Core, the sections of the rods are locked in place and separated easily with the Screw Lock Joint feature!

Model Number	Rod Length [m]	No. of Sections	Closed Length (cm)	Lure Weight [g]	Line Weight [PE]	Type
S96ML	2.90	2	149.5	MAX56	MAX2.5	SPINNING
S100ML	3.05	2	157.0	MAX56	MAX2.5	SPINNING
S96M	2.90	2	149.5	MAX70	MAX3	SPINNING
S100M	3.05	2	157.0	MAX70	MAX3	SPINNING
S106M/PS	3.20	2	164.3	MAX70	MAX3	SPINNING
S96MH	2.90	2	149.5	MAX90	MAX4	SPINNING
S100MH	3.05	2	157.0	MAX90	MAX4	SPINNING
S106MH/PS	3.20	2	164.3	MAX90	MAX4	SPINNING
S96H	2.90	2	149.5	MAX120	MAX5	SPINNING
S100H	3.05	2	157.0	MAX120	MAX5	SPINNING
S106H/PS	3.20	2	164.3	MAX120	MAX5	SPINNING
S98XH	2.95	2	151.8	MAX150	MAX6	SPINNING
S100MH-3	3.05	3	116.4	MAX90	MAX4	SPINNING
S100H-3	3.05	3	116.4	MAX120	MAX5	SPINNING
S100XH-3	3.05	3	116.4	MAX150	MAX6	SPINNING



*PS: Plugging Special
※1: M.L. Power

COLTSNIPER SS NEW

The COLTSNIPER SS introduces standard rod models performing fantastically in Shore Jigging and Plugging scenes. With significant improvements in long casts and power, bring these rods to beaches, shores and rock-fishing spots to feel the upgrade in your hands. Long casts or powerful fights, these rods help preserve stamina due to their light weight cultivated from weight-reducing efforts such as the separate grip feature.

Model Number	Rod Length [m]	No. of Sections	Transport Length (cm)	Lure Weight [g]	Line Weight [PE]	Type
S96M	2.90	2	149.5	MAX60	MAX2.5	SPINNING
S100M	3.05	2	157.0	MAX60	MAX2.5	SPINNING
S106M	3.20	2	164.0	MAX60	MAX2.5	SPINNING
S96MH	2.90	2	149.5	MAX80	MAX3	SPINNING
S100MH	3.05	2	157.0	MAX80	MAX3	SPINNING
S106MH	3.20	2	164.0	MAX80	MAX3	SPINNING
S96H	2.90	2	149.5	MAX100	MAX4	SPINNING
S100H	3.05	2	157.0	MAX100	MAX4	SPINNING
S106H	3.20	2	164.0	MAX100	MAX4	SPINNING

TELESCOPIC

S100M-T	3.05	3	117.6	MAX45	MAX2.5	SPINNING
S100MH-T	3.05	3	117.6	MAX65	MAX3	SPINNING



T: Telescopic



COLTSNIPER XTUNE S100H

COLTSNIPER XR S100ML

COLTSNIPER SS S100H

COLTSNIPER SS S100MH-T

REEL TECHNOLOGY

JDM SPINNING REELS

EXPORT SPINNING REELS

BAITCAST REELS

SW OVERHEAD REELS

ELECTRIC REELS

YUMENA/ GLOSSARY

ROD TECHNOLOGY

SALTWATER RODS

BOAT RODS

BASS RODS

SPECIAL RODS

LIFESTYLE GEAR



COLTSNIPER BB S100MH

EXAGE SHORE CAST

VENGEANCE SHORE GAME S100M

COLTSNIPER BB NEW

A basic model with an upgrade in swinging power.

The Coltsniper BB boasts high resistance against twisting loads with the Hi-Power X structure. It provides you with the fundamentals any angler would need for shore jigging - casting distance, power and ease to use. Choose anywhere from ML power rating for various light jigs to M and H power ratings for big plugs and heavy weight jigs. The Coltsniper BB is a highly performing rod with even the convenient 3-piece rods included in the latest lineup.

Model Number	Rod Length [m]	No. of Sections	Closed Length (cm)	Lure Weight [g]	Line Weight [PE]	Type
S96ML	2.90	2	149.3	MAX50	MAX2	SPINNING
S100ML	3.05	2	157.0	MAX50	MAX2	SPINNING
S96M	2.90	2	149.3	MAX60	MAX2.5	SPINNING
S100M	3.05	2	157.0	MAX60	MAX2.5	SPINNING
S100M-3	3.05	3	109.7	MAX60	MAX2.5	SPINNING
S106M	3.20	2	164.4	MAX60	MAX2.5	SPINNING
S96MH	2.90	2	149.3	MAX80	MAX3	SPINNING
S100MH	3.05	2	157.0	MAX80	MAX3	SPINNING
S100MH-3	3.05	3	109.7	MAX80	MAX3	SPINNING
S106MH	3.20	2	164.4	MAX80	MAX3	SPINNING
S96H	2.90	2	149.3	MAX100	MAX4	SPINNING
S100H	3.05	2	157.0	MAX100	MAX4	SPINNING
S100H-3	3.05	3	109.7	MAX100	MAX4	SPINNING



EXAGE

SHORE CAST

First impression counts. That's why we gave this rod a pearl white finish and camouflage designs on part of the rod. This is the weapon of choice for shore casting anglers. With the use of Fuji K guides and a fast taper tip, this rod is easy on the anglers during whole day of casting. Oversized EVA handle also help gives better leverage during prolonged fights.

Model Number	Rod Length [ft]	No. of Sections	Lure Weight [g]	Line Weight [lb]	Type
S802M	8'	2	6-28	8-16	SPINNING
S902M	9'	2	6-28	8-16	SPINNING
S1002M	10'	2	6-28	8-16	SPINNING

VENGEANCE SHORE GAME

If you are fishing from shore, either in a pond or by the coast, this rod is the perfect rod for you. Made with high density pressure carbon and full equipped with double foot Fuji K guides, this rod is made strong for the largest freshwater pelagic species. Additional reel seat locknut and BRC rear end ensures a stable and solid fight even in the longest struggle. Available in 4 different SKUs, 6'6", 7', 9' and 10'.

Model Number	Rod Length [ft]	No. of Sections	Lure Weight [g]	Line Weight [lb]	Type
S66M	6'6"	2	25-50	10-25	SPINNING
S70M	7'0"	2	30-60	15-32	SPINNING
S90M	9'0"	2	90-120	15-40	SPINNING
S100M	10'0"	2	90-120	15-40	SPINNING



ARCIERA KIHADA 190

ARCIERA BG H175

ARCIERA OTOSHIKOMI MH240

ARCIERA KIHADA

In addition to being highly resistant to torsional loads, the ARCIERA KIHADA is also highly responsive. With a well balanced tip to convey information to anglers without scaring off the target, and a mid section which provides a cushioning effect to prevent leader line breaks, this rod comes with a butt power capable of withstanding even aggressive electric pumping motions. The whole concept of the ARCIERA KIHADA is "Reeling in large monsters with ease and comfort."

Model Number	Rod Length [m]	No. of Sections	Closed Length (cm)	Weight [g]	Sinker Weight [No.]
170	1.70	1	170.0	535	80-400
190	1.90	1	190.0	545	80-400



1PIECE

7:3ACTION

ARCIERA BG

A standing rod with traits inherited from the Chemare series.

The main component of the blanks is the UD material which makes it supple yet highly rebounding. This carbon-based UD material is light yet strong to complement the structural technologies (Spiral X Core & Hi-Power X). The soft and supple tip of the rod helps to convey accurately the movement of the bait while the strong butt (with ferrule) of the rod is strong and sturdy to keep you assured that it will conquer any fish in any of your standing fights!

Model Number	Rod Length [m]	No. of Sections	Closed Length (cm)	Weight [g]	Sinker Weight [No.]
M135	1.35	1	134.8	440	30-200
MH180	1.80	2	149.0	524	60-250
H175	1.75	2	144.0	524	60-300



※1

M135

M135・MH180

1PIECE

6:4ACTION

MH180・H175

H175

2PIECE DETACHABLE BUTT

7:3ACTION

※1 : MH180・H175

ARCIERA OTOSHIKOMI NEW

A soft tip on tough reliable blanks.

The main blanks is made of a composite comprising of the supple yet highly rebounding UD glass and the light yet strong carbon materials, finished off with the Spiral X Core and Hi-Power X blanks technology. The Tough Butt Ferrule structure where the blanks penetrates into the inner parts of the reel seat, makes the rod extremely sensitive to change in underwater conditions. The soft tip allows live baits to swim freely while the rod butt reassures you of the rod's hooking performance, stopping the divers (fish) in their tracks. Arciera Otoshikomi really is the rod with the exact actions anglers look for in bottom fishing.

Model Number	Rod Length [m]	No. of Sections	Closed Length (cm)	Weight [g]	Sinker Weight [No.]
M225	2.25	2	196.0	505	40-150
MH240	2.40	2	210.9	545	60-180
H230	2.30	2	200.9	570	80-200



2PIECE DETACHABLE BUTT

7:3ACTION



DEEP CHASER 200-200

DEEP SOLDIER 205 0

OCEA E J B63-4

DEEP CHASER

Fishing the deep reefs is becoming more popular each season and the Deep Chaser series has a couple of purpose built rods for Shimano's medium size electric reels. The Deep Chasers possess a specialised action and guide arrangement that provides superior bite detection, but also the strength required to retrieve fish from down deep. The blanks are further reinforced by Shimano's Spiral X Core rod technology to remove twist and increase performance.

Model Number	Rod Length [m]	No. of Sections	Closed Length [cm]	Weight [g]	Sinker Weight [No.]
150-195	1.95	2	151.1	250	80-250
200-200	2.00	2	161.5	290	100-300
300-205	2.05	2	179.4	550	200-500





※1 : 150-195 + 200-200



DEEP SOLDIER

Blanks have tightened UD glasses, the main material, with the further evolved Spiral X Core and are equipped with a strong muscle force to overcome high-load cranking. Responding to excesses when pulling up large fish, Hi-Power X has thick carbon tape to the tip for best effect. By utilising Excite Top, the rod gives increased hand and eye sensitivity.

205 0  

6: 4 ratio for medium to deep light. Mainly used for No. 120-250 Weights are assumed. The rear grip is a semi-long specification that can be held by hand.

205 I  

6: 4 ratio with kinme as the main target. Weights 250-400 are mainly used. It is a short bat specification that supports a standing rod.

205 II  

7: 3 tone supports up to full-scale Kinme. With the bat power that carries the Max 600 weight, it is an item for deep fields that can be rooted. It is a short bat specification that supports a standing rod.

Model Number	Rod Length [m]	No. of Sections	Closed Length [cm]	Weight [g]	Sinker Weight [No.]
205 0	2.05	2	173.2	550	100-300
205 I	2.05	2	179.5	610	200-500
205 II	2.05	2	179.5	655	250-600





OCEA E J

Special Blanks Design allows the rod to withstand against fast moving targets underwater and also the powerful cranking force of the latest BeastMaster EJ. The long front grip also enable the use of both hands during operations and fights with sea monsters!

Model Number	Rod Length [m]	No. of Sections	Closed Length [cm]	Weight [g]	Lure Weight [g]	Line Weight [PE]	Type
B63-3	1.91	2	130	164	MAX230	MAX3	Baitcast
B63-4	1.91	2	130	172	MAX300	MAX4	Baitcast
B63-5	1.91	2	130	175	MAX350	MAX5	Baitcast
B63-6	1.91	2	130	181	MAX400	MAX5	Baitcast







Chermare **BG** NEW

The blank is made with UD glass as the main material while carbon is incorporated into the design from the backbone to the butt. The blank which forms the basis of a rod is improved with both the Spiral X and Hi Power X structure, resulting in an extremely high resistance against torsional loads. This rod has a well balanced tip which allows anglers to feel the slightest change of underwater activity but at the same time, does not scare the target off while taking the bait. With the strength to fight diving monsters, this rod is a partner most sought after by anglers which love the big game.

Model Number	Rod Length [m]	No. of Sections	Closed Length [cm]	Weight [g]	Sinker Weight [No.]
M165	1.65	1	165.0	480	60-250
MH205	2.05	2	172.4	TBC	60-300
H165	1.65	1	165.0	490	60-300

Spiral
CORE

X
HI-POWER

NANOPITCH

M165 · H165 1PIECE MH205 2PIECE DETACHABLE BUTT

TOUGH BUTT
FERRULE

M165 · MH205 6:4 ACTION H165 7:3 ACTION

※ 1 : MH205

BeastMaster KIHADA

BeastMaster KIHADA was born, pursuing true strength. A supple, tenacious, high strength with High Power X structure combined in the design. High Power X significantly increased the torsional rigidity and torsional strength and at the same time it has the power to catch large runs securely. The high-strength parts that had been selectively chosen were hardened and finished in a single piece that makes BeastMaster Kihada the best electric fishing rod without question.

Model Number	Rod Length [m]	No. of Sections	Closed Length [cm]	Weight [g]	Sinker Weight [no.]
175	1.75	1	175	730	80-400

X SOLID
HI-POWER

ONE PIECE 6:4 ACTION

BANDIT KIHADA

An action which boasts lifting power to challenge even the larger sizes of Yellowfins out there.

With the blanks being made with carbon and UD material using the Spiral X Core technology, you get a blanks which is highly sensitive and responsive while at the same time, being super resistant to twisting loads. The Bandit Kihada has been fine tuned from tip to butt for optimal rebound and fighting strength. All these improvements is to make sure that you can cut the distance with the fish efficiently and stop them from dashing away underwater. An exciting standing rod to face any large species underwater.

Model Number	Rod Length [m]	No. of Sections	Closed Length [cm]	Weight [g]	Sinker Weight [No.]
170	1.71	2	139.1	345	80-400
190	1.91	2	159.1	365	80-400

Spiral
CORE

NANOPITCH

170 2PIECE DETACHABLE BUTT 7:3 ACTION 190 6:4 ACTION

DEPTH-HUNTER

Introducing the all new Depth Hunter which is fully equipped with the latest technology - Spiral X and Hi- Power X; bringing you next level performance! Designed with a 6:4 action, this rod is perfect for live bait fishing. The soft taper allows for a more natural presentation of bait as the rod will gently lift and drop with the current. With UD GLASS construction, the rod is definitely set to withstand any abuse sent in its way!

Model Number	Rod Length [m]	No. of Sections	Weight [g]	Sinker Weight [No.]
135L	1.35	1	380	30-200
165L	1.65	1	440	60-250
165MH	1.65	1	450	60-300

X
SPIRAL

X
HI-POWER

6:4 ACTION



Chermare BG H165

BEASTMASTER KIHADA 175

BANDIT KIHADA 170

DEPT-H-HUNTER 135L

BASS FISHING





POISON ULTIMA

One of Shimano's flagship models, the Poison Ultima is constantly on its own, walking the path of evolution towards its ultimate form. A highly sturdy yet light core rod equipped with the Spiral X Core technology.

Model Number	Rod Length [m]	No. of Sections	Transport Length (cm)	Lure Weight [g]	Line Weight [lb]	Type
162L-S	1.88	1	188.0	3.5-10	6-12	BAITCAST
163MH	1.91	1	191.0	10-30	10-20	BAITCAST
166M	1.98	1	198.0	7-21	8-16	BAITCAST
1610L-BFS	2.08	1	208.0	3.5-10	6-12	BAITCAST
1610M	2.08	1	208.0	7-21	8-16	BAITCAST
1611ML+	2.11	2	180.5	5-21	7-16	BAITCAST
170M	2.13	2	183.3	7-21	8-16	BAITCAST
170MH	2.13	2	182.7	10-30	10-20	BAITCAST
172H	2.18	2	186.5	12-42	12-25	BAITCAST
174MH-G	2.24	2	191.7	10-35	10-20	BAITCAST
264/66SUL-S	1.93/1.98	2	168.4	1-5	2-4	SPINNING
264UL/M	1.93	1	193.0	2-15	1.5-8	SPINNING
2610L-S	2.08	1	208.0	2-7	2.5-5	SPINNING



※1: 1610L-BFS, 1611ML+, 172H, 264UL/M, 2610L-S
 ※2: EXCLUDING 1610L-BFS, 1611ML+, 172H, 264UL/M, 2610L-S ※3: 264/66SUL-S, 264UL/M, 2610L-S
 ※4: 264UL/M, 2610L-S ※5: 1610L-BFS, 1611ML+, 172H ※6: EXCLUDING 1610L-BFS, 1611ML+, 172H
 ※7: 2610L-S ※8: 264/66SUL-S ※9: 162L-S ※10: 162L-S ※11: EXCLUDING 162L-S
 ※12: EXCLUDING SOLID TIP MODELS ※13: 170M

POISON ULTIMA 5 PIECE NEW

The Poison Ultima is a 5-piece model with the shape and sensitivity of the ultimate bass rod. From tip, to the butt to the grip, this multi piece rod performs as if it was a one-piece rod with minimum overlapping of sections at each joint. The Step Length Design gives the rods a natural bend while displaying a sharp reflex in the tip.

Model Number	Rod Length [m]	No. of Sections	Transport Length (cm)	Lure Weight [g]	Line Rating (lb)	Type
POISON ULTIMA 5 PIECE (BAIT)						
166-BFS/5	1.98	5	47.4	3.5-10	6-12	BAITCAST
1610M-5	2.08	5	49.2	7-21	8-16	BAITCAST
1610MH-5	2.08	5	49.0	10-30	10-20	BAITCAST
174MH+5	2.24	5	52.7	10-42	10-20	BAITCAST
POISON ULTIMA 5 PIECE (SPINNING)						
266L-5	1.98	5	48.0	3-10	MAX1.2 [PE]	SPINNING



※1: 166L-BFS/5, 174MH+5, 266L-5 ※2: SPINNING ※3: BAITCAST



POISON ULTIMA 1610M-5

POISON ULTIMA 266L-5



POISON ULTIMA 163MH

POISON ULTIMA 166M

POISON ULTIMA 1610L-BFS

POISON ULTIMA 264/66SUL-S

POISON ULTIMA 264UL/M



POISON GLORIOUS NEW

Innovative technologies developed through on-site experience. The evolution of the POISON series will not stop here.

Model Number	Rod Length [m]	No. of Sections	Closed Length (cm)	Lure Weight [g]	Line Weight [PE]	Type
161L-BFS	1.85	1	185.0	3.5-10	MAX1.5	BAITCAST
164MH	1.93	1	193.0	10-30	MAX4	BAITCAST
165XH-SB	1.96	1	196.0	MAX150	MAX6	BAITCAST
166M	1.98	1	198.0	7-21	MAX3	BAITCAST
1610M	2.08	2	179.1	7-21	MAX3	BAITCAST
1610MH	2.08	2	178.6	10-30	MAX4	BAITCAST
170H	2.13	2	181.7	14-42	MAX5	BAITCAST
174MH+	2.24	2	192.1	10-42	MAX4	BAITCAST
2510UL	1.78	1	178.0	2-7	MAX0.8	SPINNING
263ML	1.91	1	191.0	4-12	MAX1.2	SPINNING
266L	1.98	1	198.0	3-10	MAX1	SPINNING
267UL+	2.01	2	177.6	2-10	MAX0.8	SPINNING
268M+	2.03	2	177.1	5-21	MAX1.5	SPINNING
2610L/MH	2.08	2	182.1	3-21	MAX1	SPINNING
2610L-S	2.08	2	181.1	2-7	MAX0.8	SPINNING

※1

※2

※3

※4

※5

※1: 267UL+ ※2: 161L-BFS, 164MH, 170H
 ※3: 166M, 1610M, 1610MH, 174MH+, 2510UL, 263ML, 266L, 267UL+, 268M+, 2610L-S, 2610L/MH
 ※4: 2610L-S ※5: EXCLUDING SOLID MODELS

POISON GLORIOUS XC

Another Glorious gift for crankbait fans. A discerning glass composite model with the Ultimate Blanks Design.

Model Number	Rod Length [m]	No. of Sections	Closed Length (cm)	Lure Weight [g]	Line Weight [lb]	Type
166LG/BFS	1.98	2	170.6	3.5-12	6-12	BAITCAST
1610ML-G	2.08	2	177.6	5-18	7-14	BAITCAST
170M-G	2.13	2	181.1	7-28	8-16	BAITCAST
173MH-G	2.21	2	187.6	10-35	10-20	BAITCAST

※G= REPRESENTS GLASS COMPOSITE
 ※THE NUMBER 2 IN THE ONE PIECE SERIES REPRESENTS A "GRIP JOINT" WITH A REMOVABLE GRIP.

POISON ADRENA NEW

Equipped with the latest technology - Full Carbon Monocoque Grip. Experience the sensitivity and lightness never seen before on previous Adrena models.

Model Number	Rod Length [m]	No. of Sections	Closed Length (cm)	Lure Weight [g]	Line Weight [lb]	Type
163L-BFS	1.91	1	191.0	4-12	6-12	BAITCAST
163ML	1.91	1	191.0	5-15	7-14	BAITCAST
163M	1.91	1	191.0	7-21	8-16	BAITCAST
166ML-G	1.98	1	198.0	5-18	7-14	BAITCAST
166MH	1.98	1	198.0	10-30	10-20	BAITCAST
166H	1.98	1	198.0	12-42	12-25	BAITCAST
166H-SB	1.98	1	198.0	10-56	12-25	BAITCAST
167L-BFS	2.01	1	201.0	4-12	6-12	BAITCAST
1610M-G	2.08	1	208.0	7-28	8-16	BAITCAST
1610M	2.08	1	208.0	7-21	8-16	BAITCAST
1611M+	2.11	2	180.2	7-28	8-20	BAITCAST
172M	2.18	2	187.5	7-21	6-16	BAITCAST
172H	2.18	2	186.2	12-42	12-25	BAITCAST
173MH	2.21	2	189.2	10-30	10-20	BAITCAST
174H-LM	2.24	2	190.2	10-56	12-25	BAITCAST
2510UL	1.78	1	178.0	2-7	2.5-5	SPINNING
261SUL-S	1.85	1	185.0	1-5	2-4	SPINNING
264UL	1.93	1	193.0	2-7	2.5-5	SPINNING
265UL-S	1.96	1	196.0	1.5-6	2.5-5	SPINNING
266L	1.98	1	198.0	3-10	3-6	SPINNING
267ML	2.01	1	201.0	4-12	4-8	SPINNING
268UL	2.03	1	203.0	2-7	2.5-5	SPINNING
2610UL/M	2.08	1	208.0	2-15	1.5-8	SPINNING
2611MH	2.11	2	181.6	7-21	6-12	SPINNING

POISON ADRENA CENTER CUT 2 PIECE						
163L-BFS/2	1.91	2	98.0	4-12	6-12	BAITCAST
166ML-2	1.98	2	101.5	5-15	7-14	BAITCAST
166M-2	1.98	2	101.5	7-21	6-16	BAITCAST
169XH-SB/2	2.06	2	106.2	MAX150	14-30	BAITCAST
1610M-2	2.08	2	106.5	7-21	8-16	BAITCAST
1610MH-2	2.08	2	106.5	10-30	10-20	BAITCAST
172H-2	2.18	2	111.5	12-42	12-25	BAITCAST
173MH-2	2.21	2	113.0	10-30	10-20	BAITCAST
264UL-2	1.93	2	99.0	2-7	2.5-5	SPINNING
265UL-S/2	1.96	2	100.5	1.5-6	2.5-5	SPINNING
266L-2	1.98	2	101.5	3-10	3-6	SPINNING
2610UL/M-2	2.08	2	106.5	2-15	1.5-8	SPINNING
276M-2	2.29	2	117.7	5-15	5-10	SPINNING

※1

※2

※1: 261SUL-S, 265UL-S, 265UL-S/2
 ※2: EXCLUDING SOLID TIP AND 2 PCS MODEL

REEL TECHNOLOGY
 JDM SPINNING REELS
 EXPORT SPINNING REELS
 BAITCAST REELS
 SW OVERHEAD REELS
 ELECTRIC REELS
 YUMBAU/ GLOSSARY
 ROD TECHNOLOGY
 SALTWATER RODS
 BOAT RODS
 BASS RODS
 SPECIAL RODS
 LIFESTYLE GEAR



WORLD SHAULA NEW

The 'RED' assault cannot be stopped. Crystallizing the experiences of anglers from not only Japan but also across the globe, the WORLD SHAULA is a versatile partner which brings you a whole new experience!

Model Number	Rod Length [m]	No. of Sections	Closed Length (cm)	Lure Weight [g]	Line Weight [PE]	Type
15101F-3	1.78	3	130.0	5-20	MAX1.5	BAITCAST
15102R-3	1.77	3	130.0	7-28	MAX2	BAITCAST
15103RS-3	1.78	3	130.0	10-40	MAX3	BAITCAST
1600SS-3	1.83	3	130.0	3.5-14	MAX2	BAITCAST
1602SS-3	1.82	3	130.0	7-30	MAX4	BAITCAST
1604SS-3	1.83	3	130.0	15-80	MAX6	BAITCAST
1651FF-3	1.98	3	130.0	4-16	MAX1.5	BAITCAST
1652R-3	1.98	3	130.0	7-28	MAX2	BAITCAST
1653R-3	1.98	3	130.0	10-40	MAX3	BAITCAST
1702R-2	2.13	2	130.0	7-28	MAX2	BAITCAST
1703R-2	2.13	2	130.0	10-40	MAX3	BAITCAST
1704R-2	2.13	2	130.0	15-80	MAX4	BAITCAST
1754R-2	2.29	2	130.0	15-80	MAX4	BAITCAST
1785RS-2	2.34	2	130.0	15-140	MAX6	BAITCAST
17114R-2	2.41	2	130.0	15-80	MAX4	BAITCAST
1832R-2	2.51	2	130.0	7-30	MAX2	BAITCAST
1833RS-2	2.52	2	130.0	10-45	MAX3	BAITCAST
2651F-3	1.98	3	130.0	5-15	MAX1.2	SPINNING
2652R-3	1.98	3	130.0	7-20	MAX1.5	SPINNING
2653R-3	1.98	3	130.0	10-30	MAX2.5	SPINNING
2701FF-2	2.13	2	130.0	4-14	MAX1	SPINNING
2702R-2	2.13	2	130.0	7-20	MAX1.5	SPINNING
2704RS-2	2.13	2	130.0	15-80	MAX4	SPINNING
2750FF-2	2.29	2	130.0	2-8	MAX0.8	SPINNING
2752R-2	2.29	2	130.0	7-20	MAX1.5	SPINNING
2831R-2	2.51	2	130.0	5-15	MAX1.2	SPINNING
2832RS-2	2.51	2	130.0	7-30	MAX2	SPINNING
2833RS-2	2.51	2	130.0	10-50	MAX3	SPINNING



※1 : 1702R-2, 1703R-2, 1704R-2, 1785RS-2, 17114R-2
 ※2 : 2701FF-2, 2702R-2, 2704RS-2, 2750FF-2, 2752R-2, 2831R-2, 2832RS-2, 2833RS-2

WORLD SHAULA **DREAM TOUR EDITION** NEW

Dream Tour Edition that connects great dreams. A lineup of carefully selected necessary items to fight game fish from all over the world.

Model Number	Rod Length [m]	No. of Sections	Transport Length (cm)	Lure Weight [g]	Line Weight [PE]	Type
1602RS-5	1.83	5	42.7	MAX160	MAX2	BAITCAST
1603RS-5	1.82	5	42.4	MAX180	MAX3	BAITCAST
1604RS-5	1.82	5	42.2	MAX240	MAX4	BAITCAST
1652R-5	1.98	5	46.2	MAX160	MAX2	BAITCAST
1653R-5	1.98	5	46.2	MAX180	MAX3	BAITCAST
2651F-5	1.98	5	46.7	MAX80	MAX1.2	SPINNING
2702R-5	2.13	5	47.1	MAX120	MAX1.5	SPINNING
2754R-5	2.29	5	50.3	15-80	MAX4	SPINNING
2832RS-5	2.51	5	54.7	7-30	MAX2	SPINNING



WORLD SHAULA **BG** NEW

Versatile new chapter. Trust the power.

Model Number	Rod Length [m]	No. of Sections	Transport Length (cm)	Lure Weight [g]	Line Weight [PE]	Type
1954R-3	2.90	3	130.0	40-120	MAX5	BAITCAST
2836RS-2	2.51	3	130.0	50-150	MAX6	SPINNING
2952R-3	2.90	3	130.0	15-40	MAX2	SPINNING
2953R-3	2.90	3	130.0	20-60	MAX3	SPINNING
21053R-3	3.20	3	130.0	20-60	MAX3	SPINNING
21055R-3	3.20	3	130.0	40-120	MAX5	SPINNING
21203R-3	3.66	3	130.0	20-60	MAX3	SPINNING



※1 : 1954R-3, 2952R-3, 2953R-3, 21053R-3

WORLD SHAULA **Technical Edition** NEW

Model Number	Rod Length [m]	No. of Sections	Transport Length (cm)	Lure Weight [g]	Line Weight [PE]	Type
S52UL-3/F	1.57	3	55.7	0.7-8	0.2-0.6	SPINNING
S52L-3/MD	1.57	3	55.7	1.5-10	0.3-0.8	SPINNING
S62XUL-2	1.88	2	130.0	0.4-3.5	0.2-0.6	SPINNING
S62SUL-2	1.88	2	130.0	0.6-6	0.2-0.6	SPINNING
S62UL-2/F	1.88	2	130.0	0.7-8	0.2-0.6	SPINNING
S62L-2/MD	1.88	2	130.0	1.5-10	0.3-0.8	SPINNING
S66SUL-2	1.98	2	130.0	0.6-6	0.2-0.6	SPINNING
S66UL-2/F	1.98	2	130.0	0.7-8	0.2-0.6	SPINNING
S66L-2/MD	1.98	2	130.0	1.5-10	0.3-0.8	SPINNING



EXPRIDE

A high performance rod in which Shimano has put its pride and technologies. Expride is reborn with a new design. The blanks which increase the ratio of high elastic carbon is enforced by "Hi Power X". We reduced the weight of this rod by over 10% compared to the previous models and kept its durability.

Model Number	Rod Length [m]	No. of Sections	Closed Length (cm)	Lure Weight [g]	Line Weight [lb]	Type
163ML-G	1.91	1	191.0	5-18	7-14	BAITCAST
164L-BFS	1.93	1	193.0	3.5-10	6-12	BAITCAST
165ML+	1.96	1	196.0	5-21	7-14	BAITCAST
165MH-LM	1.96	1	196.0	10-35	10-20	BAITCAST
166ML	1.98	1	198.0	5-15	7-14	BAITCAST
166M	1.98	1	198.0	7-21	8-16	BAITCAST
168L-BFS	2.03	1	203.0	3.5-10	6-12	BAITCAST
168MH	2.03	1	203.0	10-30	10-20	BAITCAST
169H	2.06	1	206.0	12-42	12-25	BAITCAST
1610M	2.08	1	208.0	7-21	8-16	BAITCAST
170M-G	2.13	2	181.3	7-25	8-16	BAITCAST
172ML+-BFS	2.18	2	186.8	4-18	7-14	BAITCAST
172MH	2.18	2	186.3	10-30	10-20	BAITCAST
172MH-G	2.18	2	185.3	10-35	10-20	BAITCAST
172H	2.18	2	185.8	12-42	12-25	BAITCAST
173MH-LM	2.21	2	188.3	10-35	10-20	BAITCAST
173XH	2.21	2	188.3	14-56	14-30	BAITCAST
176MH	2.29	2	196.8	10-30	10-20	BAITCAST
176H	2.29	2	196.3	12-42	12-25	BAITCAST
176H-SB	2.29	2	195.3	14-56	12-25	BAITCAST
1710H+-SB	2.39	2	203.6	14-84	12-25	BAITCAST
1711XH	2.41	2	206.3	14-84	14-30	BAITCAST
262UL-S	1.88	1	188.0	1.5-5	2.5-5	SPINNING
263L-S	1.91	1	191.0	2.5-10	3-6	SPINNING
264SUL-S	1.93	1	193.0	1-5	2-4	SPINNING
264UL	1.93	1	193.0	2-7	2.5-5	SPINNING
265UL+	1.96	1	196.0	2-10	2.5-6	SPINNING
265ML	1.96	1	196.0	4-12	4-8	SPINNING
266L-LM	1.98	1	198.0	3-12	3-6	SPINNING
266L	1.98	1	198.0	3-10	3-6	SPINNING
267L+	2.01	1	201.0	3-12	3-6	SPINNING
268UL-S	2.03	1	203.0	1.5-5	2.5-5	SPINNING
2610ML	2.08	1	208.0	4-12	4-8	SPINNING
270L+	2.13	2	188.4	3-12	3-6	SPINNING
164L-BFS/2	1.93	2	99.2	3.5-10	6-12	BAITCAST
166ML-2	1.98	2	101.7	5-15	7-14	BAITCAST
166M-2	1.98	2	101.7	7-21	8-16	BAITCAST
168L-BFS/2	2.03	2	104.2	3.5-10	6-12	BAITCAST
168MH-2	2.03	2	104.2	10-30	10-20	BAITCAST
1610M-2	2.08	2	106.7	7-21	8-16	BAITCAST
1610MH-SB/2	2.08	2	106.5	10-35	10-20	BAITCAST
172MH-2	2.18	2	111.7	10-30	10-20	BAITCAST
172H-2	2.18	2	111.7	12-42	12-25	BAITCAST
175H-SB/2	2.26	2	115.6	14-56	12-25	BAITCAST
262UL-S/2	1.88	2	96.5	1.5-5	2.5-5	SPINNING
263L-S/2	1.91	2	98.0	2.5-10	3-6	SPINNING
264UL-2	1.93	2	99.2	2-7	2.5-5	SPINNING
265UL+2	1.96	2	100.5	2-10	2.5-6	SPINNING
265ML-2	1.96	2	100.7	4-12	4-8	SPINNING
266L-2	1.98	2	101.7	3-10	3-6	SPINNING
2610ML-2	2.08	2	106.7	4-12	4-8	SPINNING
190XH-2	2.74	2	195.0	MAX200	14-30	BAITCAST
1910H-2	3.00	2	195.0	12-56	12-25	BAITCAST
1911XH-2	3.02	2	195.0	14-84	14-30	BAITCAST
286ML-2	2.59	2	195.0	5-21	6-21	SPINNING



*1 : 262UL-S, 262UL-S/2, 264SUL-S, 268UL-S
 *2 : 263L-S, 263L-S/2
 *3 : 265UL+, 265UL+2, 267L+

Bantam

The elements of Bass Fishing.
 Bringing new sensation to seasoned anglers!

A target of [Bantam] is understanding the essence of bass fishing and developed an All-round quality bass rod.

Baitcast series have 3 main categories - Versatile, Jig & Worm and Hardbait & Big bait. There are 9 different SKUs for Baitcast type. The high versatility of each rods can satisfy the demand of the most discerning angler. Spinning rod have 5 SKUs with high versatility as well. We studied in detail different fishing environment and the rod action most suitable. Extra care is taken to adjust the blanks to be stable and powerful when the rod is loaded. This is truly a series that will bring Bantam rods out of Japan and into the global market.

Model Number	Rod Length [m]	No. of Sections	Closed Length (cm)	Lure Weight [g]	Line Weight [lb]	Type
160ML-G	1.83	1	183.1	5-21	8-16	BAITCAST
160M	1.83	1	183.1	7-21	8-16	BAITCAST
165L-BFS	1.96	1	196.0	3.5-10	6-12	BAITCAST
166L+-BFS	1.98	1	198.0	4-12	6-12	BAITCAST
168ML-G	2.03	1	203.0	5-21	8-16	BAITCAST
168M	2.03	1	203.0	7-21	8-16	BAITCAST
168MH	2.03	1	203.0	10-30	10-20	BAITCAST
170M-G	2.13	2	181.0	7-28	10-20	BAITCAST
170M	2.13	2	182.3	7-21	8-16	BAITCAST
170MH	2.13	2	182.8	10-30	10-20	BAITCAST
170H	2.13	2	181.8	12-42	12-25	BAITCAST
172MH	2.18	2	186.8	10-30	10-20	BAITCAST
172H-FR	2.18	2	187.4	12-42	12-25	BAITCAST
173MH-SB	2.21	2	187.6	12-56	10-20	BAITCAST
173H	2.21	2	188.0	12-42	12-25	BAITCAST
174MH-G	2.24	2	191.7	10-35	12-25	BAITCAST
177XH	2.31	2	198.6	14-56	14-30	BAITCAST
1711H-SB	2.41	2	204.0	14-100	12-25	BAITCAST
180XXH-SB	2.44	2	205.4	MAX300	16-35	BAITCAST
264UL+	1.93	1	193.0	2-7	2.5-5	SPINNING
265L	1.96	1	196.0	3-10	3-6	SPINNING
267ML	2.01	1	201.0	4-12	4-8	SPINNING
2610L	2.08	1	208.0	3-10	3-6	SPINNING
2610ML	2.08	1	208.0	4-12	4-8	SPINNING
274L-SB	2.24	2	196.8	3-12	3-6	SPINNING
274M	2.24	2	196.7	5-18	4-10	SPINNING
274MH	2.24	2	195.8	7-21	6-12	SPINNING
163H-SB/2	1.91	2	114.1	14-100	12-25	BAITCAST
165L-BFS/2	1.96	2	101.2	3.5-10	6-12	BAITCAST
170M-2	2.13	2	109.7	7-21	8-16	BAITCAST
170MH-2	2.13	2	109.7	10-30	10-20	BAITCAST
264UL+2	1.93	2	99.8	2-7	2.5-5	SPINNING
267ML-2	2.01	2	103.8	4-12	4-8	SPINNING



*1 : 166L+-BFS, 274L-SB, 274M, 274MH Only



REEL TECHNOLOGY
 JIG SPINNING REELS
 EXPORT SPINNING REELS
 BAITCAST REELS
 SW OVERHEAD REELS
 ELECTRIC REELS
 YUMIVA/ GLOSSARY
 ROD TECHNOLOGY
 SALTWATER RODS
 BOAT RODS
 BASS RODS
 SPECIAL RODS
 LIFESTYLE GEAR

Scorpion NEW

Without focusing on geographical factors, the Scorpion is a multipurpose travel rod which is capable of following anglers around the world. The high portability of the rod is made possible with its One-and-Half Piece and 5-piece structures. With a regular taper making up the rod's action and a guide system which allows for both thin and thick lines to be used without problems, the Scorpion series is back, now more versatile than ever!

Model Number	Rod Length [m]	No. of Sections	Closed Length (cm)	Lure Weight [g]	Line Weight [lb]	Type
1581F-2	1.73	2	130.0	5-20	8-16	BAITCAST
1600SS-2	1.83	2	130.0	3.5-14	6-16	BAITCAST
1631FF-2	1.91	2	130.0	4-16	8-14	BAITCAST
1652R-2	1.98	2	130.0	7-28	12-22	BAITCAST
1653RS-2	1.98	2	130.0	10-40	14-30	BAITCAST
1702R-2	2.13	2	130.0	7-28	12-25	BAITCAST
1703R-2	2.13	2	130.0	10-40	14-30	BAITCAST
1704R-2	2.13	2	130.0	15-80	16-40	BAITCAST
1752R-2	2.29	2	130.0	7-28	12-25	BAITCAST
1787RS-2	2.34	2	130.0	15-240	16-70	BAITCAST
17113R-2	2.41	2	130.0	10-40	14-30	BAITCAST
2651R-2	1.98	2	130.0	5-15	5-12	SPINNING
2652R-2	1.98	2	130.0	7-20	6-14	SPINNING
2701FF-2	2.13	2	130.0	4-14	4-10	SPINNING
2702R-2	2.13	2	130.0	8-20	7-20	SPINNING
2831R-2	2.51	2	130.0	5-15	5-12	SPINNING
2832RS-2	2.51	2	130.0	7-30	10-24	SPINNING
SCORPION 5 PIECE ROD						
15101F-5	1.78	5	42.5	5-20	8-16	BAITCAST
15103RS-5	1.77	5	42.7	10-40	14-30	BAITCAST
1602R-5	1.83	5	43.8	7-28	12-22	BAITCAST
1604SS-5	1.82	5	43.0	15-80	16-50	BAITCAST
1652R-5	1.98	5	47.0	7-28	12-22	BAITCAST
2600FF-5	1.82	5	44.6	2-8	3-8	SPINNING
2602R-5	1.83	5	44.1	7-20	6-14	SPINNING
2651R-5	1.98	5	47.6	5-15	5-12	SPINNING



ZODIAS NEW

Equipped with the Carbon Monocoque Grip. FEEL the experience of an improved world class rod.

Just like a small electric current flowing across the body, feel the tingling sensation from detecting underwater activity with the carbon monocoque grip. Bringing you both the confidence to fish fearlessly and sensation for a wholesome fishing experience, this global standard Zodias rods offers games on a whole other level to anglers.

Model Number	Rod Length [m]	No. of Sections	Closed Length (cm)	Lure Weight [g]	Line Weight [lb]	Type
164L-BFS	1.93	2	166.7	4-12	6-12	BAITCAST
166ML	1.98	2	169.7	5-15	7-14	BAITCAST
166M	1.98	2	169.2	7-21	8-16	BAITCAST
167M-S	2.01	2	172.2	4-15	6-12	BAITCAST
168L-BFS	2.03	2	174.7	4-12	6-12	BAITCAST
1610ML	2.08	2	178.9	5-15	6-12	BAITCAST
1610M	2.08	2	178.2	7-21	8-16	BAITCAST
1610MH	2.08	2	177.7	10-30	10-20	BAITCAST
170M-G	2.13	2	181.1	7-28	8-20	BAITCAST
172MH	2.18	2	185.6	10-30	10-20	BAITCAST
172H	2.18	2	184.6	12-42	12-25	BAITCAST
264UL-S	1.93	2	167.7	1.5-5	2-5	SPINNING
264UL	1.93	2	167.7	2-7	2-5	SPINNING
264L	1.93	2	167.7	3-10	3-6	SPINNING
266ML-G	1.98	2	171.0	4-15	5-10	SPINNING
268L-S	2.03	2	177.3	2.5-10	3-6	SPINNING
268L	2.03	2	177.2	3-10	3-6	SPINNING
268ML	2.03	2	177.2	4-12	4-8	SPINNING
164L-BFS/2	1.93	2	99.2	4-12	6-12	BAITCAST
166ML-2	1.98	2	101.7	5-15	7-14	BAITCAST
166M-2	1.98	2	101.7	7-21	8-16	BAITCAST
166MH-2	1.98	2	101.6	10-30	10-20	BAITCAST
167M-S/2	2.01	2	103.0	4-15	6-12	BAITCAST
168L-BFS/2	2.03	2	104.2	4-12	6-12	BAITCAST
1610ML-2	2.08	2	106.8	5-15	6-12	BAITCAST
1610M-2	2.08	2	106.7	7-21	8-16	BAITCAST
1610MH/2	2.08	2	106.7	10-30	10-20	BAITCAST
170M-G/2	2.13	2	109.2	7-28	8-20	BAITCAST
172MH-2	2.18	2	111.9	10-30	10-20	BAITCAST
172H-2	2.18	2	111.7	12-42	12-25	BAITCAST
176M/2	2.29	2	117.2	7-21	8-16	BAITCAST
264UL-S/2	1.93	2	99.2	1.5-5	2-5	SPINNING
264UL/2	1.93	2	99.2	2-7	2-5	SPINNING
264L/2	1.93	2	99.2	3-10	3-6	SPINNING
266ML-G/2	1.98	2	101.7	4-15	5-10	SPINNING
268L-S/2	2.03	2	104.3	2.5-10	3-6	SPINNING
268L/2	2.03	2	104.2	3-10	3-6	SPINNING
268ML/2	2.03	2	104.2	4-12	4-8	SPINNING
270M/2	2.13	2	109.2	5-15	5-10	SPINNING



※1 : 167M-S, 167M-S/2, 264UL-S, 264UL-S/2, 268L-S, 268L-S/2
 ※2 : 167M-S, 167M-S/2





CARDIFF AX S60SUL-FF

TROUT ONE AS S60SUL-F

TROUT ONE AS B66UL-F

BASS ONE XT 166ML-2

BASS ONE XT 263L-2

CARDIFF AX

The Cardiff AX is a Japanese designed range for use with small lures for smaller predator species. The progressive action has an almost elastic type feel which absorbs unexpected pressure without compromise. Although this range offers remarkable sensitivity, it has an inner strength to cope with larger than expected predators.

Model Number	Rod Length [m]	Rod Action	No. of Sections	Closed Length [cm]	Lure Weight [g]	Line Weight [PE]	Type
S57XUL-FF	1.70	Extra Ultra Light	2	87.3	0.4-2.5	0.2-0.6	SPINNING
S60XUL-F	1.83	Extra Ultra Light	2	93.8	0.4-2.5	0.2-0.6	SPINNING
S60XUL-RG	1.83	Extra Ultra Light	2	93.8	0.4-3.5	0.2-0.6	SPINNING
S60SUL-FF	1.83	Super Ultra Light	2	93.8	0.5-3.5	0.2-0.6	SPINNING
S62SUL-F	1.88	Super Ultra Light	2	96.3	0.5-4.5	0.2-0.6	SPINNING
S62UL-F	1.88	Ultra Light	2	96.3	0.7-6	0.2-0.6	SPINNING
S66SUL-F	1.98	Super Ultra Light	2	101.3	0.5-4.5	0.2-0.6	SPINNING
S66UL-F	1.98	Ultra Light	2	101.3	0.7-6	0.2-0.6	SPINNING
B62SUL-RG	1.88	Super Ultra Light	2	96.3	1.5-6	0.2-0.6	BAITCAST
B64L-F	1.93	Light	2	99.3	1.5-7	0.2-0.6	BAITCAST



※1 : S57XUL-FF, S60SUL-FF
 ※2 : EXCLUDING S57XUL-FF, S60SUL-FF, S60XUL-RG, S62SUL-RG

TROUT ONE AS

Ultra responsive, with a slow/progressive action, the TROUT ONE AS casts remarkably well for such a lightweight rod and is at home on small streams and rivers.

Model Number	Rod Length [m]	Rod Action	No. of Sections	Closed Length [cm]	Lure Weight [g]	Line Weight [PE]	Type
S57XUL-F	1.70	Extra Ultra Light	2	87.3	0.4-2.5	0.2-0.6	SPINNING
S60XUL-F	1.83	Extra Ultra Light	2	93.8	0.4-2.5	0.2-0.6	SPINNING
S60SUL-F	1.83	Super Ultra Light	2	93.8	0.5-4.5	0.2-0.6	SPINNING
S66SUL-F	1.98	Super Ultra Light	2	101.3	0.5-4.5	0.2-0.6	SPINNING
S60UL-F	1.83	Ultra Light	2	93.8	0.7-6	0.2-0.6	SPINNING
S66UL-F	1.98	Ultra Light	2	101.3	0.7-6	0.2-0.6	SPINNING
B60SUL-F	1.83	Super Ultra Light	2	93.8	1.5-4	0.2-0.6	BAITCAST
B66UL-F	1.98	Ultra Light	2	101.3	1.5-6	0.2-0.6	BAITCAST



BASS ONE XT

Basic Model reborn with luxurious specifications. Made for the latest freshwater fishing trends with specifications that defy conventions. Successfully lightened by about 10% from the previous range, gorgeous specifications are adopted such as lightweight reel seat and separate EVA grips.

Model Number	Rod Length [m]	No. of Sections	Closed Length [cm]	Lure Weight [g]	Line Weight [lb]	Type
150ML-2	1.52	2	79.2	5-14	8-16	BAITCAST
156ML-2	1.68	2	87.0	5-14	8-16	BAITCAST
162ML-2	1.88	2	97.2	5-14	8-16	BAITCAST
162M-2	1.88	2	97.2	7-21	10-20	BAITCAST
166ML-2	1.98	2	102.2	5-14	8-16	BAITCAST
166M-2	1.98	2	102.2	7-21	10-20	BAITCAST
166MH-2	1.98	2	102.2	10-28	10-24	BAITCAST
1610M-2	2.08	2	107.2	7-21	10-20	BAITCAST
1610MH-2	2.08	2	107.2	10-28	10-24	BAITCAST
1610H-2	2.08	2	107.7	12-35	12-24	BAITCAST
256UL-2	1.68	2	87.0	1-5	3-5	SPINNING
260UL-2	1.83	2	94.7	1-5	3-5	SPINNING
260L-2	1.83	2	94.7	2-7	4-7	SPINNING
263UL-2	1.90	2	98.2	1-5	3-5	SPINNING
263L-2	1.90	2	98.2	2-7	4-7	SPINNING
263ML-2	1.90	2	98.2	4-8	4-8	SPINNING
266L-2	1.98	2	102.2	2-7	4-7	SPINNING
266ML-2	1.98	2	102.2	3-10	4-8	SPINNING

REEL TECHNOLOGY
 JDM SPINNING REELS
 EXPORT SPINNING REELS
 BAITCAST REELS
 SW OVERHEAD REELS
 ELECTRIC REELS
 YUMIYA / GLOSSARY
 ROD TECHNOLOGY
 SALTWATER RODS
 BOAT RODS
 BASS RODS
 SPECIAL RODS
 LIFESTYLE GEAR



PANZAR

Panzar is a specially craft series to cater to all the lure enthusiast's demand. There are various SKUs to choose from to suit the different kind of lure fishing that you want to do. This is a super versatile spinning model. If you can only bring one rod to go fishing, this is the rod that we would recommend!

Model Number	Rod Length [m]	No. of Sections	Lure Weight [g]	Line Weight [lb]	Type
166ML-2	1.98	2	5-15	8-16	BAITCAST
166M-2	1.98	2	7-21	10-20	BAITCAST
168L-BFS	2.03	2	4-12	6-12	BAITCAST
1610ML-2	2.08	2	5-15	10-20	BAITCAST
1610M-2	2.08	2	7-21	10-20	BAITCAST
258M-2	1.72	2	4-18	8-16	SPINNING
262ML-2	1.88	2	4-12	5-10	SPINNING
264L-2	1.93	2	3-10	4-8	SPINNING
264M-2	1.93	2	4-18	8-16	SPINNING
268ML-2	2.03	2	4-12	6-12	SPINNING
272ML-2	2.19	2	7-35	12-25	SPINNING
276ML	2.30	2	10-35	12-25	SPINNING

PANZAR S.T.C.

Model Number	Rod Length [ft]	No. of Sections	Lure Weight [g]	Line Weight [lb]	Type
S6070-5	6'-7'	5	4-12	5-12	SPINNING
S7080-5	7'-8'	5	7-26	6-16	SPINNING
S8090-5	8'-9'	5	8-30	7-20	SPINNING
S9010-5	9'-10'	5	10-35	8-25	SPINNING

PANZAR UD

UD=Ultra Durable. We made this rod to allow anglers to confidently handle any unknown fishing situation. Panzar UD series is available in 3 length, 6'3", 6'9" and 7'2". Choose the rod length according to your fishing environment. For close quarters and fishing from a small boat, the 6'3" would be perfect and can handle lures up to 40g easily. For shore based fishing, the 7'2" is highly recommended as the extra length means an extra long cast. Standard equipped with Fuji BRC butt, it gives a good grip to anglers when performing a power cast, All 3 size comes standard with Fuji Alconite LN guides and ECS reel seat.

Model Number	Rod Length [ft]	No. of Sections	Lure Weight [g]	Line Weight [PE]	Type
B63H	6'3"	2	MAX50	1.3	BAITCAST
B69H	6'9"	2	MAX60	2.4	BAITCAST
B72H	7'2"	2	MAX70	2.5	BAITCAST

BASSTERRA EV

Equipped with Full Fuji Components, this rod pushes above its weight class. Rod action is tuned to be fast to cater to different fishing situation. Extra attention is placed to ensure that this rod is durable and will bring joy to angler for years to come.

Model Number	Rod Length [ft]	No. of Sections	Lure Weight [g]	Line Weight [PE]	Type
S56M	5'6"	2	4-18	8-16	SPINNING
S60M	6'0"	2	4-18	8-16	SPINNING
S66MH	6'6"	2	4-18	8-16	SPINNING
S70MH	7'0"	2	12-35	12-20	SPINNING
S80MH	8'0"	2	16-40	12-25	SPINNING
S9010MH	9'->10'	3	18-40	16-30	SPINNING

LUREMATIC

The Lurematic range of rods are designed to suit South East Asia Fishing style. Made to produce medium to medium heavy action, the action of the rod promises to deliver a satisfying user experience. Equipped with Fuji guide and Fuji reel seat, this rod is made to be durable and still maintain its sensitivity to ensure that you feel even the slightest nibble on the rod. Available from 5ft to 9ft, the Lurematic series is affordable and a must have for all lure anglers.

Model Number	Rod Length [m]	No. of Sections	Closed Length [cm]	Lure Weight [g]	Line Weight [lb]	Type
S50M	1.52	2	78.8	4-18	8-16	SPINNING
S56M	1.68	2	86.8	5-21	8-16	SPINNING
S60L	1.83	2	94.3	5-14	5-10	SPINNING
S60M	1.83	2	94.3	7-28	8-16	SPINNING
S66L	1.98	2	101.9	5-14	5-10	SPINNING
S70UL	2.14	2	109.5	0.8-10	2-6	SPINNING
S76UL	2.29	2	117.0	0.8-12	2-6	SPINNING
S80L	2.44	2	125.8	4-21	3-12	SPINNING
S86ML	2.59	2	133.3	6-28	4-16	SPINNING
S90ML	2.74	2	141.0	6-28	4-16	SPINNING
S66MH	1.98	2	102.0	7-35	10-20	SPINNING
S70MH	2.13	2	109.7	7-35	12-25	SPINNING
S80MH	2.44	2	125.3	10-42	12-30	SPINNING
S90MH	2.74	2	140.5	10-50	12-30	SPINNING
B58L	1.73	2	89.2	7-18	10-16	BAITCAST
B66ML	1.98	2	101.9	8-22	10-22	BAITCAST

LUREMATIC MB

High mobility multi piece rods with excellent lightness.

Model Number	Rod Length [m]	No. of Sections	Closed Length [cm]	Lure Weight [g]	Line Weight [lb]	Type
S80L-4	2.44	4	66.2	5-25	3-10	SPINNING
S86ML-4	2.59	4	69.9	6-32	4-10	SPINNING
S90ML-4	2.74	4	73.7	6-32	4-10	SPINNING

BASSTERRA XT

For the anglers looking for the finesse touch, this rod is for you. Fully equipped with Fuji K guides and SiC guides at the tip, this rod offers incredible sensitivity to the angler. Carefully placed guides allows sharp and crisp casting while retaining top power in the blank. Split butt design helps reduce overall weight and the use of cork gives it the premium finish.

Model Number	Rod Length [ft]	No. of Sections	Lure Weight [g]	Line Weight [lb]	Type
166M	6'6"	1	5-28	12-25	BAITCAST
1610M	6'10"	1	5-28	12-25	BAITCAST
265ML	6'5"	1	4-14	6-14	SPINNING
269M	6'9"	1	5-21	8-16	SPINNING

SLX

SLX offers tournament level performance at a price that all anglers can afford. With versatile actions throughout the lineup, there is an SLX to cover any technique. SLX rods feature an attractive and sensitive carbon foregrip, as well as a Shimano custom reel seat.

Model Number	Rod Length [ft]	No. of Sections	Lure Weight [g]	Line Weight [lb]	Type
58ML	5'8"	1	5-18	10-20	BAITCAST
510M	5'10"	1	7-28	15-20	BAITCAST
60MH	6'0"	1	10-35	15-40	BAITCAST
70MH2	7'0"	2	5-17	8-30	SPINNING
60M2	6'9"	2	7-21	10-40	SPINNING

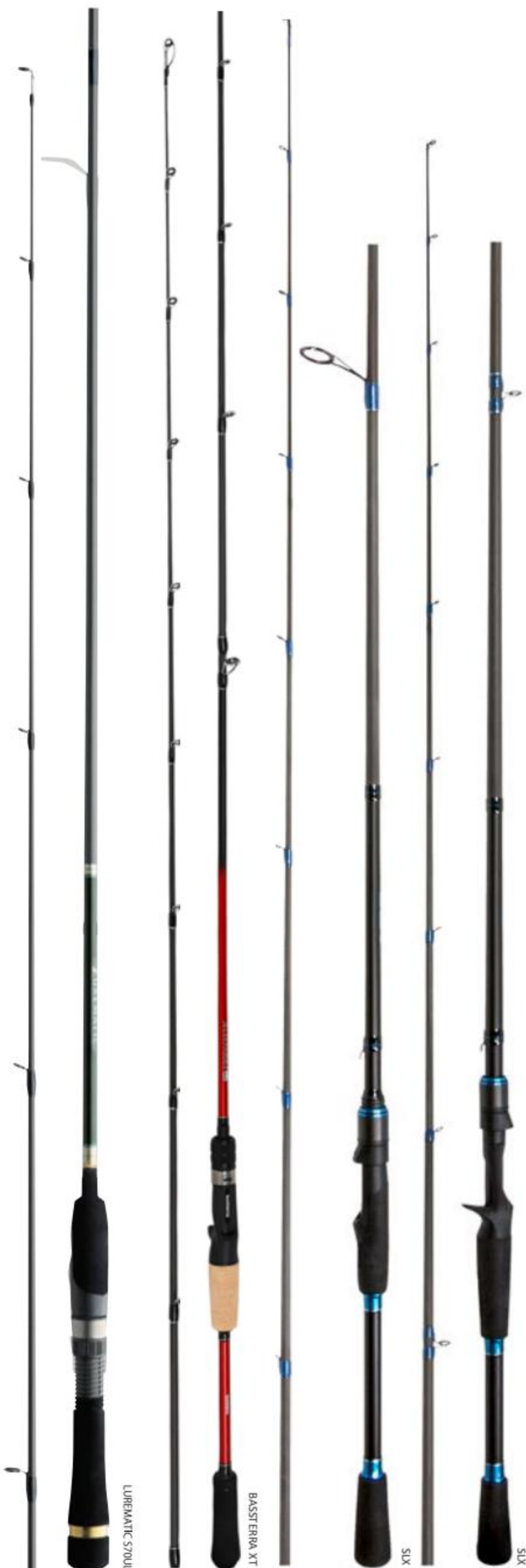

LUREMATIC 570UL

BASSTERRA XT

SLX

SLX



Majestic NEW

The one for all.

Majestic is a one-stop solution to entry level fresh and saltwater lure games. The Majestic range of rods is equipped with a combination of EVA and cork grip for better ergonomics, durable O-ring guides for casting enjoyment, hook keeper to hold your lures and also a rod bag for storage.

Available in 13 models for every situation, a must have for lure anglers!

Model Number	Rod Length [m]	No. of Sections	Closed Length [cm]	Lure Weight [g]	Line Weight [PE]	Type
B64LBFS-2	1.93	2	99.2	3-15	0.6-1.5	BAITCAST
B66ML-2	1.98	2	103.0	5-20	0.8-2	BAITCAST
B68LBFS-2	2.03	2	104.2	3-15	0.6-1.5	BAITCAST
B610ML-2	2.08	2	106.7	5-20	0.8-2	BAITCAST
B610M-2	2.08	2	106.7	7-28	1-2.5	BAITCAST
B610MH-2	2.08	2	106.7	10-35	1.2-3	BAITCAST
B76ML-2	2.29	2	117.7	5-20	0.8-2	BAITCAST
B76M-2	2.29	2	117.7	7-28	1-2.5	BAITCAST
S66L-2	1.98	2	103.0	5-15	0.3-1	SPINNING
S610ML-2	2.08	2	106.7	7-21	0.4-1.2	SPINNING
S74MH-2	2.24	2	118.2	10-30	0.8-2	SPINNING
S80ML-2	2.44	2	124.7	7-21	0.4-1.2	SPINNING
S80M-2	2.44	2	124.7	8-24	0.6-1.5	SPINNING



SCIMITAR BX

The Scimitar BX is a very versatile spinning rod for all-round predator fishing. Provided with a modern design and XT40+BIOFIBRE blank which is fast and provides good casting and fish fighting abilities for a very affordable price. The action of the rod is fast, which means this rod is suitable for modern lure fishing techniques where the angler needs to work the lure in order to give it action. The versatile range contains rods for almost every type of predator fishing, from UL (perch, trout) to XH (big pike and other big predators).

Model Number	Rod Length [m]	No. of Sections	Lure Weight [g]	Type
S63ML	1.91	2	7-21	SPINNING
S66MHB	1.98	2	10-28	SPINNING
S70MB	2.13	2	7-21	SPINNING
S70MH	2.13	2	14-42	SPINNING
S810M	2.69	2	7-35	SPINNING
S90H	2.74	2	21-56	SPINNING
S90XH	2.74	2	28-84	SPINNING
S70HB	2.13	2	10-35	SPINNING
C66MHB	1.98	2	10-28	BAITCAST
C70MHB	2.13	2	10-28	BAITCAST



STIMULA AX TOUGH

Shimano Stimula AX Tough rods were built to deliver a reliable rod series for years of great fishing on the water. This hardy line of rods comes in a variety of lengths and actions that will handle a wide range of species and build a strong legacy of fishing experiences.

Model Number	Rod Length [ft]	No. of Sections	Lure Weight [g]	Type
S56MLSA	5'6"	2	1-10	SPINNING
S66MSA	6'6"	2	7-35	SPINNING
S66MNSA	6'6"	2	10-56	SPINNING
S70MSA	7'0"	2	7-35	SPINNING
S70MNSA	7'0"	2	10-56	SPINNING
B66MNSA	6'6"	2	10-56	BAITCAST
B70MH	7'0"	2	10-56	BAITCAST



LESATH NEW



LESATH GS 2602F

The latest generation of freshwater competition spinning rods. When fishing in stocked ponds, it is common for the fishes inside to be wary especially with species like Patin, Bighead Carp and Rohu. These notoriously finicky fishes requires a rod with a ultra-sensitive tip to register the tiniest bites and still possess the power to control and stop these rampaging fish from swimming to stuck. The design is a representation of classic design using modern techniques creating the perfect blend in form and function.

Model Number	Rod Length [ft]	No. of Sections	Closed Length (cm)	Lure Weight [g]	Line Weight [lb]	Type
2602F	6'0"	2	95	4-18	8-16	SPINNING



DETACHABLE ROD RETAINER

CI4+ REEL SEAT



BASSTERRA *GS*

Uncompromising & surprising performance from a production rod which performs like a custom built rod. Aero guide design ensures line slither through the guides with minimal resistance. The light weight & ergonomic Perfection reel seat found in this new rod provides a firm & comfortable grip for the angler to make every cast to be smooth & accurate. Bassterra GS is your perfect weapon for Galatama style competition use!

Model Number	Rod Length [m]	No. of Sections	Lure Weight [g]	Line Weight [lb]	Type
2562F	5'6"	2	4-18	8-16	SPINNING
2602F	6'0"	2	4-18	8-16	SPINNING

BASSTERRA *EV GS* NEW

Model Number	Rod Length [m]	No. of Sections	Lure Weight [g]	Line Weight [lb]	Type
S56M	5'6"	2	4-18	8-16	Spinning
S60M	6'0"	2	4-18	8-16	Spinning

AERNOS *GS*

Galatama Style Fishing has its own unique requirement. To cater, we built the Aernos GS 2602. This rod features a fast action table with full Fuji SiC guide for smooth line transition through the guides. At the base of the handle, we added a EVA knob to give a stable hold onto rod holders.

Model Number	Rod Length [m]	No. of Sections	Lure Weight [g]	Line Weight [lb]	Type
2562	5'6"	2	7-21	8-16	SPINNING
2602	6'0"	2	7-21	8-16	SPINNING





Surf Lander

Top Blank Construction; Spiral X. Top reinforcement: High Power X and not forgetting top quality Fuji component. This rod is a high spec rod that comes at a reasonable price. This rod is designed to cast far with its unique tape, ergonomic shape, Cascon grip and Fuji SiC guide.

This rod employs the latest K-guide from Fuji to reduce wind knots during your casts.

Model Number	Rod Length [m]	No. of Sections	Closed Length [cm]	Weight [g]	Sinker [no.]
365FX	3.65	3	129.0	305	18-25
405FX	4.05	3	143.0	335	18-25
365EX	3.65	3	129.0	325	20-30
405EX	4.05	3	143.0	360	20-30
365DX	3.65	3	129.0	355	23-30
405DX	4.05	3	143.0	390	23-30
405CX	4.05	3	143.0	420	25-35
405BX	4.05	3	143.0	450	27-35



365FX also available in yellow

SURF GAZER

A model specially made for casters who wish to challenge themselves and dive into the surfcasting section of the fishing sport. Suppressing the effects of torsional loads imposed during casting motions, the rod is equipped with Hi Power X technology to convey the power of the caster into the cast efficiently.

Model Number	Rod Length [m]	No. of Sections	Closed Length [cm]	Weight [g]	Sinker [no.]
405EX	4.05	3	143.0	345	20-30
405DX	4.05	3	143.0	375	23-30
405CX	4.05	3	143.0	400	25-35
425CX	4.25	3	150.0	445	25-35
405BX	4.05	3	143.0	435	27-35
425BX	4.25	3	150.0	475	27-35



SWINGCAST

Renewing a staple in Shimano's range of three-piece surf rods is the renewed Swingcast surf rod which now comes in 2 different lengths 4.25m, 4.50m. Built on technically superior material, this range is designed for anglers who want longer casts every time! Equipped with Fuji MN alconite guides, this rod is the perfect choices for anglers who prefer to use nylon line for surf casting. This is a serious rod for the long caster.

Model Number	Rod Length [m]	No. of Sections	Casting Weight [g]	Type
425BX	4.25	3	225	SPINNING
450BX	4.50	3	225	SPINNING



AERLEX SURF

AERLEX SURF

Aerlex Surf is a rod that exudes a quiet confidence. Smoky blue comestic finish, this is a generalist rod that will suit most surf anglers. Available in three lengths, this model has a forgiving action made for easy long casts.

Model Number	Rod Length [m]	No. of Sections	Closed Length [cm]	Casting Weight [g]	Type
425BXG	4.25	3	150.0	MAX225	SPINNING
450BXG	4.50	3	159.0	MAX225	SPINNING
500BXG	5.00	3	174.0	MAX225	SPINNING



NEXAVE SURF

NEXAVE SURF

The Nexave Surf (3PC) is a mid-segment rod with excellent casting capabilities and beautiful looks. The 450 model has DPS reel seat. It's built to cast big distances, while at the same time keeping good bite detection. The tip is tubular (hollow) for extra far distance casting.

Model Number	Rod Length [m]	No. of Sections	Closed Length [cm]	Casting Weight [g]	Type
450BX	4.50	3	158.0	MAX225	SPINNING



VENGEANCE BX

VENGEANCE BX

The Vengeance Surf rod is renewed and improved in blank, guides and looks.

- Strongly improved blank which has much more power. The rod is much stiffer, more responsive and powerful. This results in better casting distance.
- The tip sections have reduced diameters (0,5 mm less) which makes them lighter and more sensitive for better bite registration.
- Cast Control Grip for good grip when casting.

Model Number	Rod Length [m]	No. of Sections	Casting Weight [g]	Type
425BXX	4.25	3	225	SPINNING
450BXX	4.50	3	225	SPINNING

Surf Lander

Top Blank Construction; Spiral X. Top reinforcement: High Power X and not forgetting top quality Fuji component. This rod is a high spec rod that comes at a reasonable price. This rod is design to cast far with its unique tape, ergonomic shape Cascon grip and Fuji SiC guide. This rod employs the latest K-guide from Fuji to reduce wind knots during casting.

Model Number	Rod Length [m]	No. of Sections	Closed Length [cm]	Weight [g]	Sinker [no.]
405EX-T	4.05	4	117.0	370	20-30
425EX-T	4.26	4	124.0	400	20-30
405DX-T	4.05	4	117.0	395	23-30
425DX-T	4.26	4	124.0	430	23-30
405CX-T	4.05	4	117.0	415	25-35
425CX-T	4.26	4	124.0	450	25-35
405BX-T	4.05	4	117.0	445	27-35
425BX-T	4.26	4	124.0	490	27-35



SURF LEADER NEW

The Surf Leader is the ultimate rod to use for surf fishing where you need portability without any compromise on performance. Everything about this rod is purpose built and no effort has been spared to make it a serious big fish fighting tool. The rod features full Fuji SiC guides that sit on our propriety Shimano guides grooves to prevent twisting. It also comes with a Cascon Grip and a lightweight Fuji plate type reel seat.

Model Number	Rod Length [m]	No. of Sections	Closed Length [cm]	Weight [g]	Sinker [no.]
405EX-T	4.05	4	115.0	350	20-30
425EX-T	4.25	4	122.0	380	20-30
385DX-T	3.85	4	112.0	350	23-30
405DX-T	4.05	4	115.0	375	23-30
425DX-T	4.25	4	122.0	410	23-30
450DX-TL	4.50	5	105.0	405	23-30
405CX-T	4.05	4	115.0	400	25-35
425CX-T	4.25	4	122.0	435	25-35
450CX-TL	4.50	5	105.0	440	25-35
405BX-T	4.05	4	115.0	430	27-35
425BX-T	4.25	4	122.0	470	27-35



SURF CHASER

Equipped with Hi-Power X, there is no compromise on the performance of this affordable yet reliable surf rod. Fuji reel seat and Cascon grip usually found on higher end models are placed on this rod.

Model Number	Rod Length [m]	No. of Sections	Closed Length [cm]	Weight [g]	Sinker [no.]
385FX-T	3.86	4	113.0	315	18-25
385EX-T	3.86	4	113.0	340	20-30
405EX-T	4.05	4	116.0	370	20-30
425EX-T	4.26	4	123.0	400	20-30
405DX-T	4.05	4	116.0	395	23-30
425DX-T	4.26	4	123.0	430	23-30
405CX-T	4.05	4	116.0	425	25-35
425CX-T	4.26	4	123.0	465	25-35
405BX-T	4.05	4	116.0	460	27-35
425BX-T	4.26	4	123.0	505	27-35



SURF LANDER 425 CX-T

SURF LEADER 405DX-T

SURF CHASER 425EX-T



SPEEDCAST 425CXT

SPEEDCAST

The Speedcast surf rod has unbelievable casting ability due to the specially engineered blanks. The rod is lightweight and display a powerful, crisp casting performance that can launch light weight to maximum distance. This rod comes equipped with Fuji Components to deliver the best cast, every cast!

Model Number	Rod Length [m]	No. of Sections	Closed Length [cm]	Sinker [no.]	Type
405CXT	4.05	4	114.0	25-35	SPINNING
425CXT	4.25	4	119.0	25-35	SPINNING
450CXT	4.50	4	104.0	25-35	SPINNING
425BXT	4.25	4	119.0	27-35	SPINNING



SPEEDCAST FV 360FXT

SPEEDCAST FV

Lightweight with a powerful and crisp casting performance!

Experience unbelievable casts with the specially engineered blanks. This rod is also fully equipped with Fuji Components.

Model Number	Rod Length [m]	No. of Sections	Closed Length [cm]	Sinker [no.]	Type
360FXT	3.60	4	103.0	18-25	SPINNING
425CXT	4.25	4	120.0	25-35	SPINNING
425BXT	4.25	4	120.0	27-35	SPINNING



SPIN POWER 425 BX-T

SPIN POWER Telescopic

Ready to take your surf casting to the highest level? Spinpower is your choice! This unique telescopic rod removes all notion that telescopic rod lacks power. Constructed with Shimano Spiral X, this rod has the power to handle up to 40 gou sinker! Oversized butt with treated rough surface ensures that the angler gets a good grip when doing a power cast!

Model Number	Rod Length [m]	Closed Length [cm]	No. of Sections	Casting Weight [No.]
405DX-T	4.05	128.5	4	23-30
425DX-T	4.26	135.5	4	23-30
405CX-T	4.05	128.5	4	25-35
425CX-T	4.26	135.5	4	25-35
405BX-T	4.05	128.5	4	27-35
425BX-T	4.26	135.5	4	27-35
405AX-T	4.05	128.5	4	30-40
425AX-T	4.26	135.5	4	30-40



HOLIDAY SPIN / 405CX-T

HOLIDAY SPIN Telescopic

The Holiday Spin is designed with lightweightness in mind. This allows anglers to fish with comfort. The feel of butt section has also been revamped and improved with a new coating method. The Cascon grip installed on the rod has further improved Cast Control efforts, making the Holiday Spin an outstanding entry model to casters.

Model Number	Rod Length [m]	No. of Sections	Closed Length [cm]	Weight [g]	Sinker [no.]	Type
305HX-T	3.05	4	88.0	210	10-20	SPINNING
335GX-T	3.35	4	95.5	245	15-23	SPINNING
365FX-T	3.65	4	104.0	300	18-25	SPINNING
385FX-T	3.85	4	109.0	340	18-25	SPINNING
385EX-T	3.85	4	109.0	360	20-30	SPINNING
405EX-T	4.05	4	114.0	390	20-30	SPINNING
425EX-T	4.25	4	119.0	415	20-30	SPINNING
405DX-T	4.05	4	114.0	410	23-30	SPINNING
425DX-T	4.25	4	119.0	445	23-30	SPINNING
405CX-T	4.05	4	114.0	438	25-35	SPINNING



CATANA GARUDA SPECIAL

CATANA

GARUDA SPECIAL

Garuda is Eagle in Bahasa Indonesia. Like an eagle, this rod is swift and deadly. With its Fast Fast action, this rod puts the power into the hands of the anglers allowing him to catch the most fish in the shortest time. In a competition environment, every gram matters!

Model Number	Rod Length [m]	No. of Sections	Closed Length (cm)
4505	4.50	4	103.0
5406	5.40	5	103.0
6307	6.30	6	103.0



LIANG FENG

涼風

The LIANG FENG is our tilapia competition special. Rod action is tuned to a specific 8:2 action needed for the speed style fishing required in the competitive environment.

Aggressive styling with special touches like rubber screen and counter balance end plug gives maximum responsiveness to the angler's desire. Available in 2 power, 12-5H and 12-7H.

Model Number	Rod Length [ft]	No. of Sections	Weight [g]
12-5H	12'	4	100
12-7H	12'	4	107





CATANA AX TROLLING

CATANA AX Trolling

The Catana AX Trolling benefits from a deep progressive action and strong heavy duty guides, making it more than up to the challenge of taming large pelagic species. There is more than enough power through the blank to make sure you are always in control. The Catana also features under wrapped guides to secure them in place and a multiplier aluminium reel seat. This range has all you need to catch the biggest fish.

Model Number	Rod Length [m]	No. of Sections	Closed Length [m]	Weight [g]	Line Weight [lb]	No. of Guides
CATAXTRL12	2.13	2	1.76	578	12	8
CATAXTRL20	2.13	2	1.76	593	20	8
CATAXTRL30	2.13	2	1.76	586	30	7
CATAXTRL50	2.13	2	1.76	654	50	7

BIOFIBRE



CATANA CX TROLLING LITE

CATANA CX Trolling Lite

This is the ideal live baiting rod to catch pelagic species. The rod is a little longer than a traditional trolling rod to make it easier to fish from smaller boats with outboard engines. The deep progressive action and heavy duty guides will withstand any hard fighting fish and help you to land fish more efficiently.

Model Number	Rod Length [m]	No. of Sections	Closed Length [m]	Weight [g]	Line Weight [lb]	No. of Guides
CATCXTRLL6	2.19	2	1.78	536	6	10
CATCXTRLL12	2.19	2	1.78	536	12	10
CATCXTRLL16	2.19	2	1.78	587	16	9
CATCXTRLL20	2.19	2	1.78	591	20	9



VENGEANCE TROLLING

VENGEANCE

With a remarkable combination of performance and value, the Vengeance uses XT30 + Geofibre blanks for strength. Perfect for anglers new to trolling from a small boat fishing for small coral species, the range has four models from a lightweight 12lb up to a powerful 50lb model that's suitable for live bait trolling and drifting.

Model Number	Rod Length [m]	No. of Sections	Closed Length [m]	Weight [g]	Line Weight [lb]	No. of Guides
VTRL12	2.05	1	1.76	530	12	8
VTRL20	2.05	1	1.76	550	20	8
VTRL30	2.05	1	1.76	600	30	7
VTRL50	2.05	1	1.76	633	50	7

Sephia SHORE EGING

Sephia LIMITED

Be IMPRESSED by the rods' light weight when holding it, be SURPRISED at how easy and light the rods cut through the air when making casts, and get EXCITED when you hear the whipping sound from the rods cutting the wind.

Model Number	Rod Length [m]	No. of Sections	Closed Length [cm]	Lure Weight [no.]	Line Weight [PE]	Type
S83L	2.51	2	129.0	1.5-3.5	0.3-0.8	SPINNING
S77ML	2.31	2	119.0	1.8-3.8	0.4-1	SPINNING
S85ML	2.57	2	132.0	1.8-3.8	0.4-1	SPINNING
S89ML	2.67	2	137.2	1.8-3.8	0.4-1	SPINNING
S86M	2.59	2	133.0	2-4	0.5-1	SPINNING



※1 : EXCLUDING S 86M

Sephia XTUNE NEW

Refining the series with lightness, rod sensitivity and operability. The demands and expectations on eging rods have crystallized into this High Grade model!

Model Number	Rod Length [m]	No. of Sections	Closed Length [cm]	Lure Weight [no.]	Line Weight [PE]	Type
S86L	2.59	2	133.3	1.5-3.5	0.3-0.8	SPINNING
S79ML	2.36	2	121.5	1.8-3.8	0.4-1	SPINNING
S82ML	2.49	2	128.0	1.8-3.8	0.4-1	SPINNING
S86ML	2.59	2	133.0	1.8-3.8	0.4-1	SPINNING
S810ML	2.69	2	138.0	1.8-3.8	0.4-1	SPINNING
S92ML+	2.79	2	143.0	1.8-3.8	0.4-1	SPINNING
S79M	2.36	2	121.5	2-4	0.5-1	SPINNING
S86M	2.59	2	133.0	2-4	0.5-1	SPINNING
S90M	2.74	2	140.5	2-4	0.5-1	SPINNING



※1 : S86L, S79ML, S82ML, S86ML, S810ML, S92ML+

Sephia CI4+

Focused on its operability, the SEPHIA CI4+ series offers whip-like moving rods with slender bodies to improve control.

Model Number	Rod Length [m]	No. of Sections	Closed Length [cm]	Lure Weight [no.]	Line Weight [PE]	Type
S803ML	2.51	2	128.9	1.5-3.5	0.3-0.8	SPINNING
S806L	2.59	2	132.9	1.5-3.5	0.3-0.8	SPINNING
S803ML	2.51	2	128.9	1.8-3.8	0.4-1	SPINNING
S806ML	2.59	2	132.9	1.8-3.8	0.4-1	SPINNING
S806ML-S	2.59	2	132.9	1.8-3.5	0.4-1	SPINNING
S803M	2.51	2	128.9	2-4	0.5-1	SPINNING
S806M	2.59	2	132.9	2-4	0.5-1	SPINNING
S806M-S	2.59	2	132.9	2-4	0.5-1	SPINNING
S810M	2.69	2	137.9	2-4	0.5-1	SPINNING
S906M	2.90	2	148.4	2-4	0.5-1	SPINNING
S806MH	2.59	2	132.9	2.5-4.5	0.6-1.2	SPINNING



※1 : S806ML-S, S806M-S
※2 : S803L, S806L



Sephia LIMITED S86M

Sephia XTUNE S92ML+

Sephia CI4+ S803L

Sephia SS

The SEPHIA SS rods exhibit a more natural bend and have an average weight of 95g across the lineup.

Model Number	Rod Length [m]	No. of Sections	Closed Length [cm]	Lure Weight [no.]	Line Weight [PE]	Type
S83L	2.51	2	129.0	1.5-3.5	0.3-0.8	SPINNING
S86L	2.59	2	133.0	1.5-3.5	0.3-0.8	SPINNING
S76ML-S	2.29	2	118.0	1.8-3.8	0.4-1	SPINNING
S76ML	2.29	2	118.0	1.8-3.8	0.4-1	SPINNING
S83ML	2.51	2	129.0	1.8-3.8	0.4-1	SPINNING
S86ML	2.59	2	133.0	1.8-3.8	0.4-1	SPINNING
S86ML-S	2.59	2	133.0	1.8-3.8	0.4-1	SPINNING
S89ML	2.67	2	137.0	1.8-3.8	0.4-1	SPINNING
S83M	2.51	2	129.0	2-4	0.5-1	SPINNING
S86M	2.59	2	133.0	2-4	0.5-1	SPINNING
S86M-S	2.59	2	133.0	2-4	0.5-1	SPINNING
S92M+	2.80	2	143.5	2-4.5	0.5-1	SPINNING
S86MH	2.59	2	133.0	2.5-4.5	0.6-1.2	SPINNING



※1 : S76ML-S, S86ML-S, S86M-S ※2 : S83L, S86L

Sephia TT NEW

The high performance rod Sephia TT emphasizes the ability to operate the most important technique - "jerk" in eging with a light and automatic feeling. Designed so that the whole body of the rod bends flexibly, the rod jerks easily just by moving the wrist lightly. In addition, it is easy to grasp the timing of jerk and cast, establishing an intuitive "automatic" performance.

Model Number	Rod Length [m]	No. of Sections	Closed Length [cm]	Lure Weight [no.]	Line Weight [PE]	Type
S83L	2.51	2	129.0	1.5-3.5	0.3-0.8	SPINNING
S86L	2.59	2	133.0	1.5-3.5	0.3-0.8	SPINNING
S83ML	2.51	2	129.0	1.8-3.8	0.4-1	SPINNING
S86ML	2.59	2	133.0	1.8-3.8	0.4-1	SPINNING
S83M	2.51	2	129.0	2-4	0.5-1	SPINNING
S86M	2.59	2	133.0	2-4	0.5-1	SPINNING
S89M	2.67	2	137.0	2-4	0.5-1	SPINNING
S86MH	2.59	2	133.0	2.5-4.5	0.6-1.2	SPINNING



※1 : S83L, S86L

Sephia BB

With Hi-Power X from the base of the blanks all the way to the tips, the SEPHIA BB cuts off unnecessary vibrations passed along the rod.

Model Number	Rod Length [m]	No. of Sections	Closed Length [cm]	Lure Weight [no.]	Line Weight [PE]	Type
S83L	2.52	2	129.4	1.5-3.5	0.3-0.8	SPINNING
S86L	2.59	2	133.2	1.5-3.5	0.3-0.8	SPINNING
S80ML	2.44	2	125.6	1.8-3.8	0.4-1	SPINNING
S83ML	2.52	2	129.4	1.8-3.8	0.4-1	SPINNING
S86ML	2.59	2	133.2	1.8-3.8	0.4-1	SPINNING
S80M	2.44	2	125.6	2-4	0.5-1	SPINNING
S83M	2.52	2	129.4	2-4	0.5-1	SPINNING
S86M	2.59	2	133.2	2-4	0.5-1	SPINNING
S89M	2.67	2	137.0	2-4	0.5-1	SPINNING
S86MH	2.59	2	133.2	2.5-4.5	0.6-1.2	SPINNING
S89MH	2.67	2	137.0	2.5-4.5	0.6-1.2	SPINNING



※1 : S83L, S86L



Sephia SS S86ML-S

Sephia TT S86ML

Sephia BB S86L

Sephia TIP EGING

Sephia XTUNE TIP EGING

With weight reducing efforts at the core of the development, Sephia XTUNE Tip Eging sees improvement in both sensitivity and operability. Specially designed for tip eging scenes, experience how sensitive these rods are during your hunt for squids!

Model Number	Rod Length [m]	No. of Sections	Closed Length [cm]	Lure Weight [g]	Line Weight [PE]	Type
S610L-S	2.08	2	175.9	MAX40	0.3-0.8	SPINNING
S700ML-S	2.13	2	178.1	MAX70	0.4-1.0	SPINNING
S605M-S	1.96	2	161.1	MAX90	0.4-1.0	SPINNING



※1 : Red Devil

Sephia CI4+ TIP EGING

Introducing two additions to the line-up, the Sephia CI4+ Tip Eging is now a more complete family with rods catering to a wider target range yet retains their sensitivity and operability.

Model Number	Rod Length [m]	No. of Sections	Closed Length [cm]	Lure Weight [g]	Line Weight [PE]	Type
S68L-S	2.03	2	170.9	MAX40	0.3-0.8	SPINNING
S511ML-S	1.80	2	147.9	MAX60	0.4-1	SPINNING
S68ML-S	2.03	2	168.4	MAX60	0.4-1	SPINNING
S511M-S	1.80	2	147.7	MAX80	0.4-1	SPINNING
S68M-S	2.03	2	168.4	MAX80	0.4-1	SPINNING
S68MH-S	2.03	2	168.2	MAX100	0.4-1	SPINNING

※1 : S68L-S,



S511ML-S S68ML-S S511M-S S68M-S ※2 : S68MH-S

Sephia SS TIP EGING

With the whole family renewed, the latest centre cut Sephia SS Tip Eging rods have now achieved performance close to the CI4+ family.

Model Number	Rod Length [m]	No. of Sections	Closed Length [cm]	Lure Weight [g]	Line Weight [PE]	Type
S511ML-S	1.80	2	93.7	MAX60	0.4-1.0	SPINNING
S66ML-S	1.98	2	102.7	MAX60	0.4-1.0	SPINNING
S70ML-S	2.13	2	110.2	MAX60	0.4-1.0	SPINNING
S66M-S	1.98	2	102.7	MAX80	0.4-1.0	SPINNING
S70M-S	2.13	2	110.2	MAX80	0.4-1.0	SPINNING



Sephia BB TIP EGING

With Hi-Power X at its core, this family of specialized tip eging rods have been equipped with the feature of a mid end rod.

Model Number	Rod Length [m]	No. of Sections	Closed Length [cm]	Lure Weight [g]	Line Weight [PE]	Type
S66ML-S	1.98	2	102.7	MAX60	0.4-1.0	SPINNING
S70ML-S	2.13	2	110.2	MAX60	0.4-1.0	SPINNING
S66M-S	1.98	2	102.7	MAX80	0.4-1.0	SPINNING
S70M-S	2.13	2	110.2	MAX80	0.4-1.0	SPINNING



※1 : S66ML-S, S70ML-S ※2 : S66M-S, S70M-S

Sephia XTUNE TIP EGING S610L-S

Sephia CI4+ TIP EGING S68ML-S

Sephia SS TIP EGING S66ML-S

Sephia BB TIP EGING S66ML-S



LIFESTYLE GEAR

APPARELS MATERIAL/ TECHNOLOGY

GORE-TEX® FABRIC

The Gore-Tex® Fabric is a durable, breathable, water resistant and also a windbreaker to get anglers through all sorts of tough situations or extreme environments. The water resistance of the fabric will last you through even a storm. This highly performing fabric not only has all the practical uses to it but is also comfortable to the touch!



DURAST

An original material from Shimano, DURAST is tough against stretches and scratches.

Made with stretchable rain wear material, it is easy to maneuver around in. DURAST shines the most in the toughest of situations as it will prove to be resistant against almost all forms of scratches.

SUN PROTECTION COOL

UPF50+ material that protects the skin from the sun. In addition to water absorption and quick drying, it supports comfortable fishing with the cooling material and heat shielding functions.



To enjoy the outdoors comfortably.

Waterproof to prevent rain and splash, and breathable to release water vapor from sweat to the outside of clothes to prevent stuffiness. It has these two performances required in the fishing scene, especially the breathability that suppresses unpleasant stickiness due to sweat which then makes rainy days comfortable.



LURE TECHNOLOGY

THROUGH WIRE

Through wire construction connects the front connecting ring to all hook anchor points for failsafe performance.

MAGNETIC WEIGHT TRANSFER

A special magnet weight transfer system that results in longer casting distance and life-like head-up profile when paused.

FLASH BOOST

FLASHBOOST

Flash boost technology suspends reflective mirror on small springs inside of the lure body. This allows the lure to constantly emit an attractive flash, even when stationary.



By using vibration such as rod action and amplifying the vibration with a spring, you can continue to invite with quick glittering flashing even during drifting without moving the lure.

LURE MATERIALS

KYORIN

Shimano's three dimensional holographic film offers remarkable life-like reality. Following as closely as possible the scales of the fish it replicates, in terms of size, shape and overlap.

狂鱗

狂鱗

Scale hologram developed in pursuit of realism!



狂鱗

"Frenzy Scales" that appeal naturally



強鱗

"Strong Scales" with enhanced appeal

3X BODY

3X Body is a combination of materials plus a reinforced design which produces higher impact resistance and up to three times the strength of standard lure construction.

UV GLOW

Special natural holographic design for increased attraction

LURE SYSTEM

AR-C SYSTEM

AR-C

The AR-C system uses an internal moving weight controlled by a spring-type centre of gravity control (PAT.P) system. During the cast, the weight moves backwards in the lure creating centrifugal force, which improves casting distance and accuracy. Once in the water, the spring automatically returns the weight to the correct central position for maximum swimming performance.

X AR-C SYSTEM

An innovative lure construction system combining a newly developed body material 'AR-C SHELL (PAT.P)' moulded with high buoyancy foam. This enables heavier weights to be used in the revolutionary 'AR-C system', which moves during and after casting. The result is longer casts combined with lures which can be retrieved very slowly in the upper layers of water.

LINE MATERIALS

IZANAS®

This product uses ultra-high strength polyethylene fiber IZANAS®.



SPECTRA®

Uses Spectra's polyethylene raw yarn. A line with a thick fiber structure contained in the fiber bundle and excellent wear resistance. Spectra is recognised as the premium braided fishing line fibre. Spectra lasts twice as long in abrasion testing as comparable material.



X-FILAMENT

Next-generation high-molecular-weight polyethylene yarn. The maximum requirement of "strong" required for PE lines has been greatly improved.



LINE WEAVING METHOD

X TOUGH CROSS

X Tough Cross incorporates a tight weave construction, which improves overall linear strength and knot strength. Another advantage is that it lowers elongation and heightens sensitivity, making it perfect for high end fishing.



TOUGH CROSS 2

The Tough Cross braiding method is now paired with the VT braiding method in the correct proportions to produce the latest evolution in line manufacturing. This evolution has yielded an unbelievable reliability which outs anglers at ease even when going up against sea monsters

TOUGH CROSS 2

ENHANCED BODY TECHNOLOGY [EBT]

Power Pro's Enhanced Body Technology [EBT] utilises original processing. The additional line treatment/processing results in an overall improvement in line toughness, abrasion resistance, and fights line dig in comparison to Spectra line.



VT METHOD

VT Method is a new PE line weaving method. The bobbins used in the weaving process twist in the opposite direction, improving linearity and surface smoothness and reducing trouble.



POWER PRO BOATGAME

Model Number	PE Rating	Breaking Strength lb (kg)	Meters
PP-F52N	0.6	10.0 (4.5)	150
	0.8	18.0 (8.0)	
	1.0	20.0 (9.1)	
	1.5	29.0 (13.1)	
	2.0	33.0 (14.9)	
	3.0	54.0 (24.5)	
PP-F62N	0.6	10.0 (4.5)	200
	0.8	18.0 (8.2)	
	1.0	20.0 (9.1)	
	1.5	29.0 (13.1)	
	2.0	33.0 (14.9)	
	3.0	54.0 (24.5)	
PP-F72N	1.0	20.0 (9.1)	300
	1.5	29.0 (13.1)	
	2.0	33.0 (14.9)	
	3.0	54.0 (24.5)	
	4.0	67.0 (30.4)	
	5.0	72.0 (32.6)	
6.0	92.0 (41.7)		



With five contrasting colours, you get accurate casting and depth placement all the time. Giving you an added advantage over anglers who uses normal braids.

Easy-to-read color pattern marking at 1m & 5m

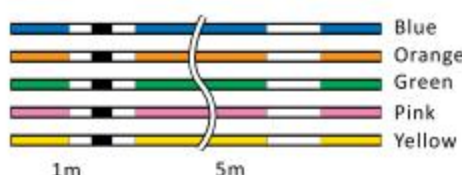

POWER PRO SUPER SLICK V2

SuperSlick has been re-engineered for a whole new level of toughness. Combining a new 8-end, dense weave construction with the proven EBT coating process, SSV2 now delivers all of the smooth, silent benefits of original SuperSlick, plus added abrasion toughness that provides the power to rip through the heaviest cover with the same force as traditional 4-end braids. Available in traditional Blue, the popular Moss Green and now introducing Hi-Vis Aqua Green for the visibility minded angler, and Onyx for those looking to catch the monster Bass.



Available colours:



Available in:
 8lb, 10lb, 15lb, 20lb, 30lb, 40lb, 50lb, 65lb, 80lb
 150yd, 300yd, 500yd, 1500yd, 3000yd

POWER PRO BRAIDED LINE

These super lines are a perfect combination when used together with Shimano tackles for the ultimate fishing experience. The Ultra-strong braided Spectra® Fiber was processed with the Enhanced Body Technology (EBT) to create an incredibly round, smooth & sensitive line. Power Pro outperforms mono-filament in any situation & leaves other super lines in the dust. Older, first-generation super lines were made of abrasive line that could cut rod guides and take a toll on equipment. PowerPro solves these problems through super slick, non-abrasive Spectra Fiber composition and unique EBT processing.



Available colours:



Available in:
 3lb, 4lb, 5lb, 8lb, 10lb, 15lb, 20lb, 30lb, 40lb, 50lb, 65lb, 80lb,
 100lb, 150lb, 200lb, 250lb
 100yd, 150 yd, 300yd, 500yd, 1500yd, 3000yd

怪力 KAIRIKI MYSTERIOUS POWER NEW

Kairiki 4 utilises the same VT Construction Method of braiding technology as Kairiki 8. Featuring four carriers, the new tight weave construction is created by applying high tension at opposing directions during the braiding process. The fibre is woven evenly at all angles, resulting in a smoother finish and a reduced diameter. This low stretch, long casting braid is an excellent choice for finesse fishing, where smoothness, sensitivity and castability is fundamental. Kairiki 4 is available from PE 0.6 (6lb) to PE 5 (50lb) in 150m and 300m spools, in Green and Multi colour.



Poundage	8lbs	10lbs	15lbs	20lbs	30lbs	40lbs	50lbs
Length	150m, 300m						
Colour	Mantis Green			Multi-Colour			

怪力 KAIRIKI MYSTERIOUS POWER

Featuring 8 carriers and incorporating premium Japanese manufacturing, the new tight weave VT construction is created through applying high tension at opposing directions during the braiding process. In the VT Construction Method, fibre is woven evenly at all angles – resulting in a smoother finish, reduced diameter and longer casts.



• New advanced 8 carrier braid • High quality, made in Japan
 • Tight weave VT construction • Smoother finish - longer casting • Smoother finish - reduced noise

Poundage	8lbs	10lbs	15lbs	20lbs	30lbs	40lbs	50lbs	60lbs	80lbs
Length	150m, 300m & 3000m								
Colour	Mantis Green		Steel Grey		Hi-Vis Yellow		Multi-Colour		

Tanatoru IZANAS

1m/5m with a simple colour pattern. Easy and convenient!

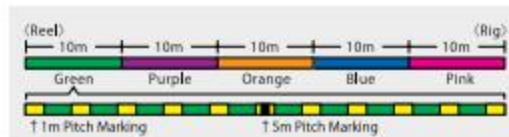

Tanatoru 4
 12.5lb, 17.8lb, 20.0lb, 31.7lb, 38.7lb, 49.1lb, 67.8lb
 150m, 200m, 300m, 500m

Tanatoru 8
 14.5lb, 18.3lb, 22.4lb, 31.7lb, 42.8lb, 54.6lb, 67.8lb,
 150m, 200m, 300m, 500m



OCEA8

Coated with a special silicon-resin material, the OCEA 8 lines are more resistant to heat. The best part is that the coating does not affect the lines' smoothness. With the use of the Tough Cross 2 technology and the VT construction method, these lines are stronger and more durable than ever!

Available colours:

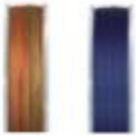

Multi colour SW Navy

Available in:
33lb, 45lb, 63lb, 76lb, 99lb, 113lb, 151lb, 173lb
300m, 400m, 500m



■ Colour/Multi colour x 10m markings, SW Navy ■ Materials/PE

HEATSINK COATING (FS-15 only) SALTWATER PE

Filament 『X-Filament』

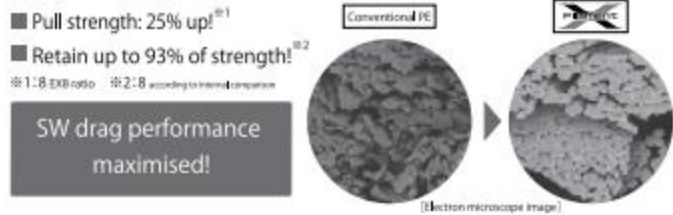

- Pull strength: 25% up!^{※1}
- Retain up to 93% of strength!^{※2}

※1: 1.8 EXB ratio ※2: 2.8 according to heat temperature

SW drag performance maximised!

- Low thermal conductivity ■ Excellent heat resistance

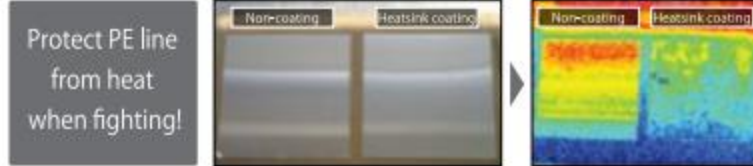

Protect PE line from heat when fighting!



Made in Japan

OCEA JIGGER MX4

MX4 SALTWATER PE

Constructed using Melt Cross technology, the new OCEA Jigger MX4 is not only highly resistant to rubbing, it is also highly sensitive. With Melt Cross technology, the line is wrapped in a special film after braiding which is then heat-shrunk to melt the surface, making it more resistant than conventional braided lines.

Available in:
MAX 5lb, 12lb, 13lb, 19lb, 20lb, 35lb, 41lb, 52lb, 65lb
200m, 300m, 600m



Made in Japan



Conventional Braided Line

Melt Cross

Braided line produced by a new production process for overhead slow jiggering

After braiding, the line is wrapped with a special film and heat-shrunk to melt the surface

OCEA LEADER EX FLUORO

High Quality Fluorocarbon leader made to the highest spec in the market. Fluorocarbon is almost invisible in the water and has zero stretch. Special construction of a strength core with a soft outer layer means the line is easier to handle. Perfect pair up with the OCEA PE EX8.

Available in:
16lb, 20lb, 25lb, 30lb, 40lb, 50lb, 60lb, 80lb, 100lb
30m, 50m



Made in Japan



Extra high density polymer for increased breaking and abrasive resistance

OCEA JIGGER LEADER Master FLUORO

Double layer construction. A thin line that catches big targets!

Ocea Jigger Master Fluoro is a leader line dedicated to jiggering that is reliable in extreme fights. Softer and higher shock absorbing performance than previous models.

Available in:
MAX 16lb, 20lb, 25lb, 30lb, 40lb, 50lb, 60lb
50m



EXAGE MONOFILAMENT LINE

- Good value all round monofilament mainline
- Exceptional knot strength
- Perfect for both freshwater and saltwater
- Made in Japan

Available in:
MAX 2.8lb, 3.9lb, 5lb, 6.3lb, 7.5lb, 9.7lb, 12.1lb, 16.5lb, 22.9lb, 28.4lb, 41.8lb
150m, 300m



TECHNIUM INVISITEC MONOFILAMENT LINE

- A monofilament that is practically invisible in the water, helping it to blend into any lake bed
- Outstanding strength
- Superb casting properties
- Sinks quickly and stays on the bottom
- Made in Japan

Available in:
4.8lb, 5.9lb, 7.2lb, 9.2lb, 11.6lb, 14.7lb, 19.8lb, 26.4lb, 33lb
150m



REEL TECHNOLOGY
JDM SPINNING REELS
EXPORT SPINNING REELS
BAITCAST REELS
SW OVERHEAD REELS
ELECTRIC REELS
YUMENA/GLOSSARY
ROD TECHNOLOGY
SALTWATER RODS
BOAT RODS
BASS RODS
SPECIAL RODS
LIFESTYLE GEAR

PITBULL 8+

IZANAS TOUGH CROSS 2 HEAT SINK COATING

THE HIGHLY REPUTED [MISSION COMPLETE] EVOLVED INTO [PITBULL] SERIES!

Shimano Pitbull 8+ is very smooth, soft braided line with super low stretch. This new Plus version has Heat Sink Coating, silicone resin surface coating, which protects braided line from heat, especially from heat from abrasion.



Made in Japan

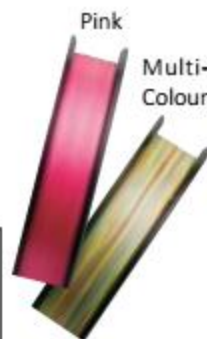
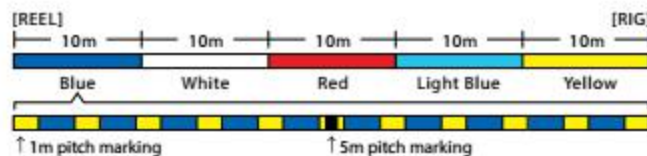

Available in:

MAX 9.3lb, 12.2lb, 14.8lb, 18.5lb, 23.5lb, 27.1lb, 31.8lb, 43.0lb
150m, 200m

PITBULL

IZANAS TOUGH CROSS 2 (PITBULL 12 ONLY)

Both suppleness and smoothness. PE line for ultra-low elongation lure casting.

PITBULL 4
8.6lb, 10.3lb, 12.5lb, 17.8lb, 20.0lb, 27.0lb, 31.7lb, 38.7lb
150m, 200m, 300m

PITBULL 8
14.5lb, 18.3lb, 22.4lb, 27.0lb, 31.7lb, 42.8lb
150m, 200m, 300m

PITBULL 12
13.9lb, 18.3lb, 23.4lb, 28.4lb, 36.2lb, 43.7lb
150m, 200m

Made in Japan



Sephia 8+ NEW

IZANAS

TOUGH CROSS 2

HEAT SINK COATING

Saltwater PE



DURABILITY UP 19%. WITH A RETENTION RATIO OF 0.4 EVEN AFTER ABRASION!

Made in Japan

Available in:

MAX 8.6lb, 9.9lb, 14.5lb, 18.3lb
150m, 200m

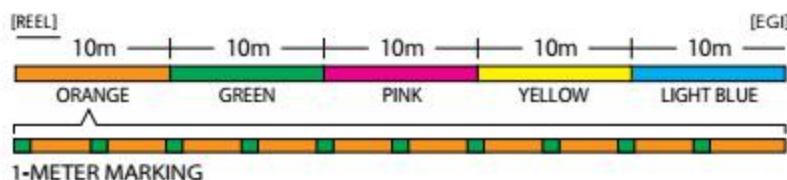

Sephia 8

IZANAS VT工法 Saltwater PE

A HIGHLY COST EFFECTIVE PE LINE WITH ENHANCED PERFORMANCE FOR EGING!

- Made in Japan (Similar to Pitbull)
- Endorsed by experience instructors!
- Uses G5 colours for better squid hunting efficiency
- Relative density of 0.98 (Sephia 8 is floating type PE line)



Made in Japan

Available in:

MAX 8.6lb, 9.9lb, 14.5lb, 18.3lb
150m, 200m

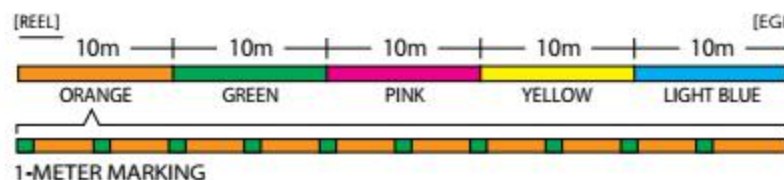

Multi-Colour

Sephia SHOCK LEADER EGING LEADER

A TENACIOUSLY STRONG YET FLEXIBLE FLUOROCARBON MADE SPECIALLY FOR EGI!

EX FLUORO

A NEW FLUOROCARBON LINE WHICH PROVIDES ANGLERS WITH A STRONG KNOT!

HYPER REEL COATING

WITH A SILICON COATING, THE LINE REPELS WATER MORE EFFECTIVELY!

TUNED TO CUT WATER EFFECTIVELY

THE STRETCH IN THE FC LINE IS PERFECT TO OPTIMISE THE ACTION OF THE ENTOURAGE EGI. IT ALSO HELPS TRANSFER ROD ACTION TO THE EGI!



Made in Japan

Available in:

MAX 7lb, 8lb, 10lb, 11lb, 14lb
30m

Sephia Clinch *FLASHBOOST*



**LURE WITH "FLASH",
STRIKE WITH "CLINCH"!**

AVAILABLE IN SIZE NO.2.5, 3.0 & 3.5!



**A CONSTANTLY
FLASHING EFFECT TO
MIMIC A LIFE-LIKE BAIT!**

PANZAR

VERSATILE LURE

EX POPPER 65



BUBBLE CHAMBER

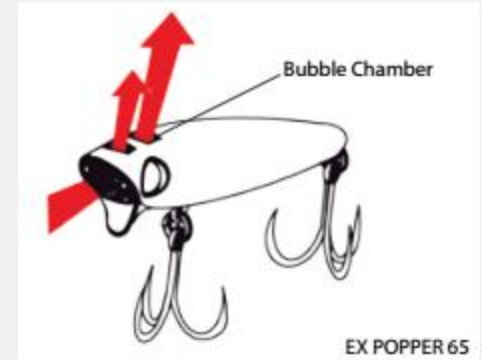

Features a unique 'Bubble Chamber' open mouth design based on how a jet engine turns low pressure into high pressure. The 'Bubble Chamber' will force water through the chamber and shoot it out of the top creating more commotion than conventional poppers, while swimming beneath the surface the lure will leave an enticing bubble trail causing fish to strike.

EX PENCIL 75



EASY SLIDE ACTION

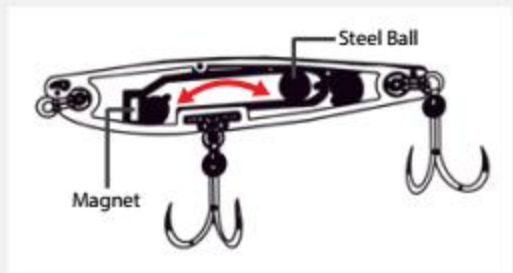

Easy to use and achieve great casting distance with "Magnet Weight Transfer System"!

MAGNET WEIGHT TRANSFER SYSTEM

Improve casting distance and swimming response.

Casting-Move Weight
 (improve casting distance)

Swimming-Fix weight
 (improve swimming response)

EX MINNOW 70F/S



COMBINATION OF STRONG WOBBLE AND ROLL ACTION



SQUIDGIES

BIO TOUGH

BIODEGRADABLE PROPRIETARY

The Synthetic Bio plastic material have proprietary to support microorganisms growth.



SPECIAL UV TREATMENT

The colours are bright, super-clear with outstanding glitter flecks and intense UV.

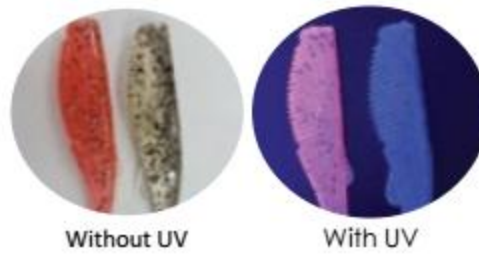

DURA STRETCH TECHNOLOGY



The new Dura-Stretch technology is an ultra tough stretchy plastic that is highly durable.

BIO TOUGH FISH

BESTSELLER!

Available in 70, 100mm



BIO TOUGH WRIGGLER



BIO TOUGH FLICK BAIT



Bantam WorldPop 69F FLASHBOOST NEW

FLASHBOOST 狂鱗



Stable flight distance and continuous appeal with Flash Boost!



Model	Length/Weight	Colours
ZR-P69U	69mm/12g	001, 002, 003, 004, 005, 006, 007, 008, 009, 010

Bantam WorldCrank 73F FLASHBOOST NEW

FLASHBOOST ARC 狂鱗



Stable flight distance and continuous appeal in water induces bite!



Model	Length/Weight	Colours
ZQ-C73U	73mm/17g	001, 002, 003, 004, 005, 006, 007, 008, 009, 010

Bantam WorldMinnow 115SP FLASHBOOST NEW

FLASHBOOST ARC 狂鱗



Strength, movement, and flight distance are all world standards. Introducing a new colour in "World Minnow" that can be used in all situations!



Model	Length/Weight	Colours
ZQ-K11T	115mm/17g	001, 002, 003, 004, 005, 006, 007, 008, 009, 010, 011, 012, 013, 014, 015

OCEA HEAD DIP 140F FLASHBOOST NEW

FLASHBOOST ARC 狂鱗



The low buoyancy design allows the entire lure to be immersed in water as much as possible, and the Flash Boost continues to shine, giving it a strong appeal that will not be interrupted during the stay.



"FLASH BOOST MECHANISM" Vibration by the spring keeps it appealing even when static



Model	Length/Weight	Colours
XU-T14U	140mm/70g	001, 002, 003, 004, 005, 006, 007, 008, 009, 010, 011, 012, 013, 014, 015

OCEA HEAD DIP 175F / 200F FLASHBOOST NEW

FLASHBOOST

ARC

Unstoppable Flashing!
New colours added to the Head Dip with Flash Boost!

狂鱗



Model	Length/Weight	Colours
XU-T17T	175mm/97g	001, 002, 003, 004, 005, 006, 007, 008
XU-T20S	200mm/135g	001, 002, 003, 004, 005, 006, 007, 008

OCEA BUBBLE DIP 220F FLASHBOOST NEW

"Flash Boost Mechanism" Continue to flash even when it stays in place!

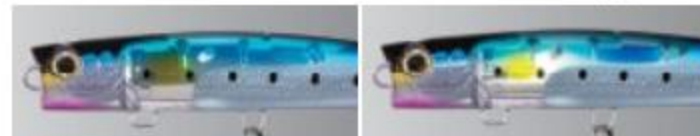

Supports single hooks aimed at amberjack and GT Attract with bubbles!



Model	Length/Weight	Colours
XU-P22T	220mm/ 93g	001, 002, 003, 004, 005, 006

OCEA SARDINE BALL 150S FLASHBOOST NEW

FLASHBOOST

ARC

Shimano has finally applied the unstoppable flashing effect onto the OCEA Sardine Ball, sinking pencils made specifically to target Tunas!

狂鱗



Model	Length/Weight	Colours
XU-S15S	150mm/71g	001, 002, 003, 004, 005, 006, 007, 008

OCEA FULL THROTTLE 240F ARC NEW

ARC

狂鱗



Adjustable action with hook!



Model	Length/Weight	Colours
XU-T24T	240mm/ 120g	001, 002, 003, 004, 005, 006

REEL TECHNOLOGY

JDM SPINNING REELS

EXPORT SPINNING REELS

BAITCAST REELS

SW OVERHEAD REELS

ELECTRIC REELS

YUMEDA/ GLOSSARY

ROD TECHNOLOGY

SALTWATER RODS

BOAT RODS

BASS RODS

SPECIAL RODS

LIFESTYLE GEAR

OCEA 別注平政 160F FLASHBOOST NEW Shimano's original Flash Boost is installed in the all-new Betchu Hiramasa!

FLASHBOOST 狂鱗



Compared to the original model Ocea Pencil Betchu Hiramasa 160F, it is equipped with a newly designed weight laid out at the rear center of gravity, and the posture during stay is adjusted in the upright direction. This tuning makes it easier to restore the posture after jerk, and it is designed with the aim of reducing dive mistakes and improving the stability in waters.

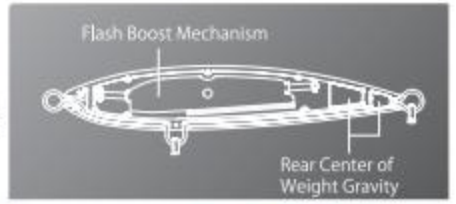

"Flash Boost Mechanism"

Vibration amplification by spring keeps inviting even when stationary



Model	Length/Weight	Colours
XU-B16U	160MM/ 61g	001, 002, 003, 004, 005, 006

OCEA PENCIL 別注平政 145F/160F/190F/220F

狂鱗

Contrary to the smaller sized pencils, these are made for targeting larger species predators!



Model	Length/Weight	Colours
OT-145K	145mm/ 46g	001, 006, 007, 008, 04J, 22T
OT-160J	160mm/ 57g	001, 006, 007, 008, 04J, 22T

Model	Length/Weight	Colours
OT-190J	190mm/ 70g	001, 006, 007, 008, 04J, 22T
OT-022L	220mm/ 114g	001, 006, 007, 008, 04J, 22T

OCEA Pebble Light NEW A slim slender jig which falls beautifully and naturally!

狂鱗



'Snap' Connection Method Quick Change Assist

A 'snap' connection method is used while maintaining strength so that small hooks used in super light jigging can be replaced quickly.



A pebble light designed to imitate the slow falling of a weak bait so that it can be 'eaten' without discomfort. Not only is the pebble stick smaller, but the balance is also adjusted with an emphasis on operability.



Model	Length/Weight	Colours
JU-P40U	92mm/40g	001, 002, 003, 004, 005, 006, 007, 008
JU-P60U	105mm/60g	001, 002, 003, 004, 005, 006, 007, 008
JU-P80U	125mm/ 80g	001, 002, 003, 004, 005, 006, 007, 008

OCEA Wing Fall NEW Wide horizontal roll, light pull resistance and fast landing. 'Teardrops' that have been sharpened to accommodate all fish species.

狂鱗

強鱗



003 Kyorin Akakin



005 Kyorin BP



Model	Length/Weight	Colours
JV-F80T	88mm/ 80g	001, 002, 003, 004, 005, 006, 007, 008
JV-F10T	95mm/100g	001, 002, 003, 004, 005, 006, 007, 008
JV-F13T	104mm/130g	001, 002, 003, 004, 005, 006, 007, 008

Model	Length/Weight	Colours
JV-F16T	111mm/160g	001, 002, 003, 004, 005, 006, 007, 008
JV-F20T	118mm/200g	001, 002, 003, 004, 005, 006, 007, 008
JV-F25T	127mm/250g	001, 002, 003, 004, 005, 006, 007, 008
JV-F33T	133mm/330g	001, 002, 003, 004, 005, 006, 007, 008
JV-F37T	138mm/370g	001, 002, 003, 004, 005, 006, 007, 008
JV-F40T	142mm/400g	001, 002, 003, 004, 005, 006, 007, 008
JV-F50T	154mm/500g	

COLTSNIPER ROCKFLAT 150S ARC- NEW

ARC-C

狂鱗

Action changes between topwater and underwater according to the cranking or winding technique of the angler!

Luring in even the more stubborn species which do not bite, this fits your Slow Jigging needs perfectly!



005 Green Katakuchi



002 Burupin Sardine



003 Purple Katakuchi



001 Kyorin Sardine



004 Kyorin Madzume



007 PB Glow



009 Kyorin Konoshiro G



010 Kyorin Flash

Model	Length/Weight	Colours
XX-S15S	150mm/67g	001, 002, 003, 004, 005, 006, 007, 009, 010

COLTSNIPER ROCKSPLASH 140F ARC- NEW

ARC-C

狂鱗

With the 3X BODY, the Coltsniper RockSplash is designed specifically for big shore games! Now with an additional "crazy" colour model!



015 Kyorin Katakuchi



010 Kyorin Madzume



013 Kyorin BP



001 Kyorin Sardine



014 Kyorin Purple



016 Kyorin Pink



017 Kyorin Konoshiro G



018 Kyorin Flash

Model	Length/Weight	Colours
OT-140Q	140mm/68g	001, 010, 013, 014, 015, 016, 017, 018

COLTSNIPER ROCKWALK 110F NEW

狂鱗

Luring fish with a diving and skating lure of smaller shapes is the Coltsniper Rock Walk.



001 Kyorin Sardine



010 Kyorin Madzume



013 Kyorin BP



014 Kyorin Purple



015 Kyorin Katakuchi



016 Kyorin Pink



017 Kyorin Konoshiro G



018 Kyorin Flash

Model	Length/Weight	Colours
OT-111Q	110mm/23g	001, 010, 013, 014, 015, 016, 017, 018

COLTSNIPER ROCKDIVE 160F ARC- NEW

ARC-C

狂鱗

Incredible casting distances with the AR-C centre of gravity shifting system. S shaped diving and sliding patterns created from the keel mouth design on the Coltsniper Rock Dive!



015 Kyorin Katakuchi



010 Kyorin Madzume



013 Kyorin BP



014 Kyorin Purple



016 Kyorin Pink



017 Kyorin Konoshiro G



018 Kyorin Flash

Model	Length/Weight	Colours
OT-160P	160mm/65g	001, 010, 013, 014, 015, 016, 017, 018

COLTSNIPER ROCKSLIDE 120S / 140S ARC- NEW

ARC-C

狂鱗

Heavy sinking pencils luring fish in with wide sliding actions. Comes with a lip head which prevents them from floating to the surface too quick!



120mm



140mm



010 Kyorin Madzume



013 Kyorin BP



014 Kyorin Purple



015 Kyorin Katakuchi



016 Kyorin Pink



017 Kyorin Konoshiro G

018 Kyorin Flash

Model	Length/Weight	Colours
OL-212P	120mm/33g	001, 010, 013, 014, 015, 016, 017, 018
OL-214P	140mm/56g	001, 010, 013, 014, 015, 016, 017, 018

COLTSNIPER サコシジグ

狂鱗

All you have to do with the Coltsniper Sagoshi Jig is to retrieve. These jigs dart with simple jerks on the rod.



Model	Length/Weight	Colours
JW-L28T	105.5mm	001, 002, 003, 004, 005, 006, 007
JW-L35T	105.5mm	001, 002, 003, 004, 005, 006, 007



Model	Length/Weight	Colours
JW-L42T	109.5mm	001, 002, 003, 004, 005, 006, 007

COLTSNIPER アオモノ/キカツチャー

狂鱗

The Coltsniper Aomono Catcher is targeted at a variety of large fish species. Hook setting performance upped to keep the hooks in after getting a strike!



Model	Length/Weight	Colours
JW-228S	71mm/ 28g	001, 002, 003, 004, 005, 006, 007, 008, 009, 010
JW-235S	78mm/ 35g	001, 002, 003, 004, 005, 006, 007, 008, 009, 010

Model	Length/Weight	Colours
JW-242S	85mm/ 42g	001, 002, 003, 004, 005, 006, 007, 008, 009, 010
JW260S	91mm/ 60g	001, 002, 003, 004, 005, 006, 007, 008, 009, 010

COLTSNIPER WONDERFALL

Fascinating fall action aiming at various fish species!

狂鱗



Model	Length/Weight	Colours
JM503Q	58mm/30g	001, 002, 003, 004, 44T, 45T, 47T
JM504Q	66mm/40g	001, 002, 003, 004, 44T, 45T, 47T

Model	Length/Weight	Colours
JM-505Q	72mm/50g	001, 002, 003, 004, 44T, 45T, 47T
JM-506Q	77mm/60g	001, 002, 003, 004, 44T, 45T, 47T

Soare Metal shot TG



Metal shot TG with new colors. Additional 40g model is good for micro jiggling.

You can use this jig not only from shore but also off shore. It has a high advantage in long casting and has a natural drift after jerking due to the front center balance design.

Model	Weight	Colours
SS-203Q	3g	31T, 32T, 33T, 34T, 35T, 36T
SS-205Q	5g	31T, 32T, 33T, 34T, 35T, 36T
SS-207Q	7g	31T, 32T, 33T, 34T, 35T, 36T
SS-210Q	10g	31T, 32T, 33T, 34T, 35T, 36T
SS-214Q	14g	31T, 32T, 33T, 34T, 35T, 36T
SS-218Q	18g	31T, 32T, 33T, 34T, 35T, 36T
SS-224Q	24g	31T, 32T, 33T, 34T, 35T, 36T
SS-232Q	32g	31T, 32T, 33T, 34T, 35T, 36T
SS-240Q	40g	31T, 32T, 33T, 34T, 35T, 36T

Soare TG イース



Good Swimming and compact tungsten body turns on the appetite of fishes

Model	Length/Weight	Colours
JT-203P	25mm/ 3.5g	01T, 02T, 03T, 04T, 05T, 06T
JT-205P	30mm/5g	01T, 02T, 03T, 04T, 05T, 06T
JT-207P	35mm/7g	01T, 02T, 03T, 04T, 05T, 06T
JT-215P	46mm/15g	01T, 02T, 03T, 04T, 05T, 06T
JT-225P	58mm/25g	01T, 02T, 03T, 04T, 05T, 06T
JT-230P	63mm/30g	01T, 02T, 03T, 04T, 05T, 06T
JT-240P	70mm/40g	01T, 02T, 03T, 04T, 05T, 06T

Sephia Clinch Rattle



Model	Length/Weight	Colours
QE-J25S	No.2.5/ 10g	001, 002, 003, 004, 005, 006, 007, 008, 009, 010, 011, 012, 013, 014
QE-J30S	No.3.0/ 15g	001, 002, 003, 004, 005, 006, 007, 008, 009, 010, 011, 012, 013, 014

Model	Length/Weight	Colours
QE-J35S	No.3.5/ 19g	001, 002, 003, 004, 005, 006, 007, 008, 009, 010, 011, 012, 013, 014
QE-J38S	No.3.8/ 24g	001, 002, 003, 004, 005, 006, 007, 008, 009, 010, 011, 012, 013, 014

Sephia Clinch

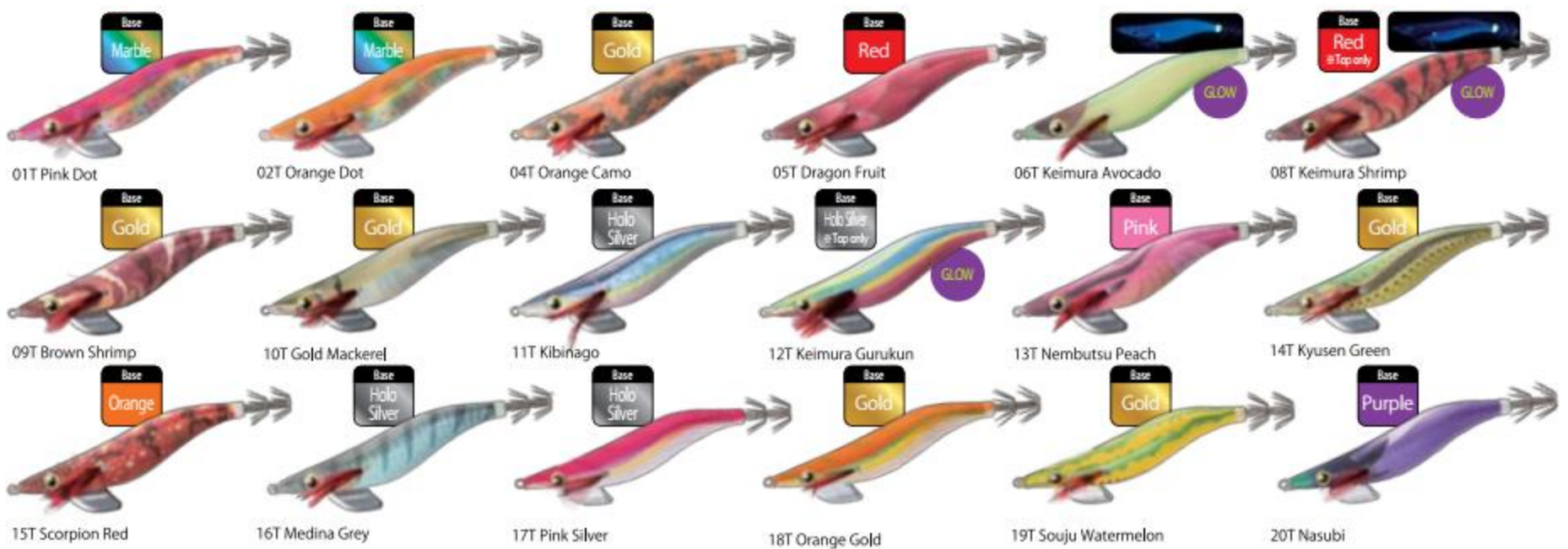

Model	Length/Weight	Colours
TYPE 1: KAERU TOBI UPPER		
QE-225Q	No. 2.5/ 10g	01T, 02T, 03T, 04T, 05T, 05T, 06T, 07T, 08T, 09T, 10T, 11T, 12T, 13T, 14T, 15T, 16T, 17T, 18T, 19T, 20T
QE-230Q	No. 3.0/ 15g	01T, 02T, 03T, 04T, 05T, 05T, 06T, 07T, 08T, 09T, 10T, 11T, 12T, 13T, 14T, 15T, 16T, 17T, 18T, 19T, 20T
TYPE 2: MONSTER BOTTOM MODEL		
QE-235Q	No. 3.5/ 19g	01T, 02T, 03T, 04T, 05T, 05T, 06T, 07T, 08T, 09T, 10T, 11T, 12T, 13T, 14T, 15T, 16T, 17T, 18T, 19T, 20T
QE-238Q	No.3.8/ 24g	01T, 02T, 03T, 04T, 05T, 05T, 06T, 07T, 08T, 09T, 10T, 11T, 12T, 13T, 14T, 15T, 16T, 17T, 18T, 19T, 20T



Sephia Entourage

Designed specifically for Tip Eging, the Sephia Entourage egis swiftly cuts through the water to target columns with varying weights.

S0 [5~15m] S1 [15~25m] S2 [25~35m] S3 [35~45m] S4 [45~55m]

Model	Size/Weight	Colours
QT-350N	3.5/S0/25g	201,202,203,206
QT-351M	3.5/S1/28g	201,202,203,206
QT-352M	3.5/S2/35g	201,202,203,206
QT-353P	3.5/S3/43g	201,202,203,206
QT-354P	3.5/S4/55g	201,202,203,206



REEL TECHNOLOGY
JIM SPINNING REELS
EXPORT SPINNING REELS
BAITCAST REELS
SW OVERHEAD REELS
ELECTRIC REELS
YUMBA/GLOSSARY
ROD TECHNOLOGY
SALTWATER RODS
BOAT RODS
BASS RODS
SPECIAL RODS
LIFESTYLE GEAR

OCEA Stinger Butterfly

Sardine Waver NEW

From groupers and snappers to Tunas and GTs, this series of pilot jigs is more than ready with new additional sizes in the lineup!

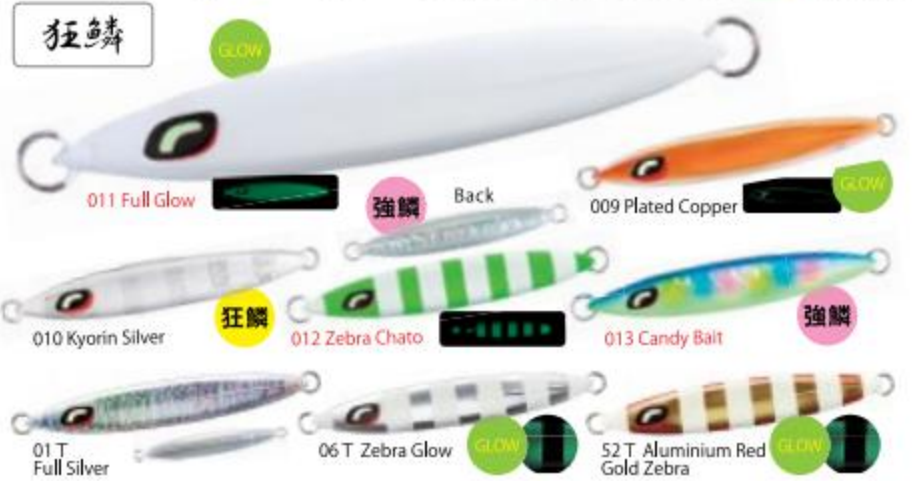

Model	Length/Weight	Colours
JT-410P	111mm/ 100g	009, 010, 011, 012, 013, 01T, 06T, 52T
JT-413P	121mm/ 130g	009, 010, 011, 012, 013, 01T, 06T, 52T
JT-416P	130mm/ 160g	009, 010, 011, 012, 013, 01T, 06T, 52T
JT-418P	135mm/ 180g	009, 010, 011, 012, 013, 01T, 06T, 52T
JT-420P	140mm/ 200g	009, 010, 011, 012, 013, 01T, 06T, 52T
JT-425P	151mm/ 250g	009, 010, 011, 012, 013, 01T, 06T, 52T



Model	Length/Weight	Colours
JV-S29T	168mm/ 290g	001, 002, 003, 004, 005, 006, 007, 008, 009
JV-S32T	174mm/ 320g	001, 002, 003, 004, 005, 006, 007, 008, 009
JV-S35T	178mm/ 350g	001, 002, 003, 004, 005, 006, 007, 008, 009
JV-S40T	189mm/ 400g	001, 002, 003, 004, 005, 006, 007, 008, 009
JV-S50T	204mm/ 500g	001, 002, 003, 004, 005, 006, 007, 008, 009

OCEA Stinger Butterfly

Easy Pebble NEW

Comfortable to retrieve, easy-to-perform long slide actions and dynamic rolling of the jigs during fall actions!



Model	Length/Weight	Colours
JV-C10S	144mm/ 100g	001, 002, 003, 004, 005, 006, 008, 009, 010, 011
JV-C14S	162mm/ 140g	001, 002, 003, 004, 005, 006, 008, 009, 010, 011
JV-C17S	174mm/ 170g	001, 002, 003, 004, 005, 006, 008, 009, 010, 011
JV-C21S	188mm/ 210g	001, 002, 003, 004, 005, 006, 008, 009, 010, 011
JV-C25S	199mm/ 250g	001, 002, 003, 004, 005, 006, 008, 009, 010, 011
JV-C29S	209mm/ 290g	001, 002, 003, 004, 005, 006, 008, 009, 010, 011
JV-C32S	216mm/ 320g	001, 002, 003, 004, 005, 006, 008, 009, 010, 011
JV-C35S	224mm/ 350g	001, 002, 003, 004, 005, 006, 008, 009, 010, 011
JV-C40S	233mm/ 400g	001, 002, 003, 004, 005, 006, 008, 009, 010, 011
JV-C50S	250mm/ 500g	001, 002, 003, 004, 005, 006, 008, 009, 010, 011
JV-F70T	259mm/ 700g	001, 002, 003, 004, 005, 006, 008, 009, 010, 011
JV-F90T	277mm/ 900g	001, 002, 003, 004, 005, 006, 008, 009, 010, 011

OCEA Stinger Butterfly

Center Sardine

OCEA Stinger Butterfly

Pebble Stick



A series of center balanced jigs suited for milder jigging motions to target bait fish

Model	Length/Weight	Colours
JT-707L	99mm/ 70g	15T, 22T, 23T, 24T, 25T, 26T, 39T, 41T
JT-709L	108mm/ 90g	15T, 22T, 23T, 24T, 25T, 26T, 39T, 41T, 56T, 61T, 62T, 64T
JT-711L	115mm/ 110g	15T, 22T, 23T, 24T, 25T, 26T, 39T, 41T, 56T, 61T, 62T, 64T
JT-713L	123mm/ 135g	24T, 25T, 35T, 39T, 41T, 56T, 61T, 62T, 64T
JT-716L	130mm/ 160g	24T, 25T, 35T, 39T, 41T, 56T, 61T, 62T, 64T
JT-720L	140mm/ 200g	24T, 25T, 35T, 39T, 41T, 56T, 61T, 62T, 64T



Model	Length/Weight	Colours
JT-908N	125mm/ 80g	001, 002, 003, 004, 005, 006, 007, 008, 009, 24T, 36T, 48T
JT-910N	135mm/ 100g	001, 002, 003, 004, 005, 006, 007, 008, 009, 24T, 36T, 48T
JT-912N	143mm/ 150g	001, 002, 003, 004, 005, 006, 007, 008, 009, 24T, 36T, 48T
JT-915N	154mm/ 150g	001, 002, 003, 004, 005, 006, 007, 008, 009, 24T, 36T, 48T
JT-920N	170mm/ 200g	001, 002, 003, 004, 005, 006, 007, 008, 009, 24T, 36T, 48T
JT-926N	185mm/ 260g	001, 002, 003, 004, 005, 006, 007, 008, 009, 24T, 36T, 48T
JT-930N	195mm/ 300g	001, 002, 003, 004, 005, 006, 007, 008, 009, 24T, 36T, 48T
JT-935N	205mm/ 350g	001, 002, 003, 004, 005, 006, 007, 008, 009, 24T, 36T, 48T

OCEA Stinger Butterfly Wing



Model	Length/Weight	Colours
JT-511M	98mm/ 110g	001, 002, 003, 004, 005, 15T, 25T
JT-513M	105mm/ 135g	001, 002, 003, 004, 005, 15T, 25T
JT-516M	112mm/ 160g	001, 002, 003, 004, 005, 15T, 25T
JT-520M	120mm/ 200g	001, 002, 003, 004, 005, 15T, 25T, 36T
JT-525M	129mm/ 250g	001, 002, 003, 004, 005, 15T, 25T, 36T
JT-530M	137mm/ 300g	001, 002, 003, 004, 005, 15T, 25T, 36T
JT-535M	147mm/ 350g	001, 002, 003, 004, 005, 15T, 25T
JT-545M	160mm/ 450g	001, 002, 003, 004, 005, 15T, 25T

OCEA Stinger Butterfly Drift Slasher NORTH PREMIUM

Invites with a fast wobbling fall between slides!



Model	Length/Weight	Colours
JU-D15U	173mm/150g	001, 002, 003, 004
JU-D20U	190mm/200g	001, 002, 003, 004
JU-D24U	202mm/240g	001, 002, 003, 004

OCEA Stinger Butterfly King Slasher Pilot jigs targeted at Tunas and Amberjacks



Model	Length/Weight	Colours
JT-312P	171mm/ 120g	001, 010, 011, 04T, 06T, 07T
JT-313P	178mm/ 135g	001, 010, 011, 04T, 06T, 07T
JT-315P	184mm/ 150g	001, 010, 011, 04T, 06T, 07T
JT-318P	195mm/ 180g	001, 010, 011, 04T, 06T, 07T
JT-320P	203mm/ 200g	001, 010, 011, 04T, 06T, 07T
JT-324P	215mm/ 240g	001, 010, 011, 04T, 06T, 07T

OCEA Stinger Butterfly Speed Slasher

A SLIM BODY WITH THE SMALLEST RESISTANCE TO CURRENTS. THESE JIGS FALL WITH INCREDIBLE SPEED!

Deep waters? Fast currents? Perfect for the Speed Slasher to come on scene!



Model	Length/Weight	Colours
JT-212Q	175mm/ 120g	01T, 02T, 03T, 04T, 05T, 06T, 09T, 10T
JT-215Q	189mm/ 150g	01T, 02T, 03T, 04T, 05T, 06T, 09T, 10T
JT-218Q	201mm/ 180g	01T, 02T, 03T, 04T, 05T, 06T, 09T, 10T
JT-220Q	208mm/ 200g	01T, 02T, 03T, 04T, 05T, 06T, 09T, 10T
JT-224Q	221mm/ 240g	01T, 02T, 03T, 04T, 05T, 06T, 09T, 10T
JT-230Q	238mm/ 300g	01T, 02T, 03T, 04T, 05T, 06T, 09T, 10T

OCEA Assist Hook Set

Based off the design of self-made hooks by one of Shimano's instructors. A set of hooks which generally covers all sorts of jigging styles!

Exclusive case for OCEA Hooks

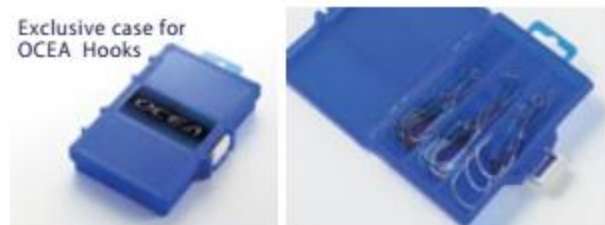

Comes with snappers for Quick Change Assist (only with EU-J01S) To quickly change between hooks while retaining hook strength in Super Light Jigging scenes.

Model	Type
EU-K03S	BAITCAST/OVER HEAD JIGGING [IN-SHORE]
EU-K02S	BAITCAST/ OVERHEAD JIGGING [MID-DEEP WATER]
EU-J03S	JIGGING WITH SPINNING REELS
EU-J01S	SUPER LIGHT JIGGING SCENES

Set Includes: BAITCAST / OVERHEAD JIGGING FOR IN-SHORE SCENES

TWIN S	TWIN M	TWIN L
×4 SETS	×4 SETS	×4 SETS
HOOK: #2/0	HOOK: #2/0	HOOK: #2/0

Set Includes: BAITCAST / OVERHEAD JIGGING FOR MID-DEEP WATERS

TWIN S	TWIN M	TWIN L
×4 SETS	×4 SETS	×4 SETS
HOOK: #3/0	HOOK: #3/0	HOOK: #3/0

Set Includes: JIGGING WITH SPINNING REELS

TWIN S	TWIN M	SINGLE L
×3 SETS	×3 SETS	×3 SETS
HOOK: #5/0	HOOK: #5/0 THICK	HOOK: #9/0

Set Includes: SUPER LIGHT JIGGING SCENES

AUTO SS	AUTO S	SET SS	SET S
×3 SETS	×3 SETS	×3 SETS	×3 SETS
HOOK: NO.9	HOOK: AS-06 #1	HOOK: NO.9	HOOK: AS-06 #1

REEL TECHNOLOGY
JIM SPINNING REELS
EXPORT SPINNING REELS
BAITCAST REELS
SW OVERHEAD REELS
ELECTRIC REELS
YUMENA/ GLOSSARY
ROD TECHNOLOGY
SALTWATER RODS
BOAT RODS
BASS RODS
SPECIAL RODS
LIFESTYLE GEAR

OCEA Stinger Butterfly

	Sardine Waver	Pebble Stick	Wing	Center Sardine	King Slasher	Speed Slasher	One Pitch
CONCEPT	SLOW JIGGING PILOT LURE	SLOW JIGGING LESS WATER RESISTANCE	SLOW JIGGING HIGH APPEAL FALLING	NEAR THE SHORE SARDINE BAIT TIME	BLUE RUNNER JIGGING QUICK JERKING	FAST FALL IN STRONG CURRENTS	ONE PITCH JERK
BALANCE	FRONT CENTER	FRONT CENTER	REAR CENTER	CENTER	CENTER	FRONT CENTER	CENTER
FALLING ACTION	RANDOM FALL	HORIZONTAL VIBRATION/DRIFT	RANDOM VIBRATION	DRIFT	ROLLING FALL SPIRAL FALL	RAPID FALL	BACK SLIDE FALL
FALLING SPEED	MID SLOW	MID FAST	SLOW	MID SLOW	MID FAST	FAST	NORMAL SPEED
JERKING ACTION	QUICK SHORT SLIDE	MIDDLE QUICK SLIDE	QUICK SLIDE	SHORT SLIDE	QUICK SLIDE & RANDOM TURN	SHORT SLIDE, SHORT DRIFT & QUICK FALL	ONE PITCH JERK
SIZE	100 ~ 250g	80 ~ 350g	110 ~ 450g	50 ~ 200g	120 ~ 240g	120 ~ 300g	80 ~ 200g
ACTION IMAGE	<p>3 TYPES OF FALLING ACTION</p> <p>random action can attract fishes!</p> <p>BACK SLIDE</p> <p>WOBLING</p> <p>ZIGZAG SLIDE</p>	<p>QUICK SLIDE AND LESS DEPTH CHANGE</p> <p>JERKING ACTION</p> <p>FALLING ACTION</p>	<p>JERKING ACTION</p> <p>Big jump sometimes</p> <p>Quick slide by powerful jerking</p> <p>Quick Zigzag fall</p> <p>Eye turning!</p> <p>Dark dart by repeated jerking</p> <p>Shaking and vibration</p> <p>Eye turning!</p> <p>Spiral fall</p> <p>FALLING ACTION</p> <p>Slide to 1!</p> <p>Vibration fall</p> <p>Spiral to 1!</p> <p>Zigzag fall</p>	<p>JERKING ACTION</p> <p>Short turn</p> <p>Short turn</p> <p>Short turn</p> <p>Short turn</p> <p>Short turn</p> <p>Short turn</p> <p>FALLING ACTION</p> <p>Slide</p> <p>Vibration</p> <p>Zigzag</p> <p>Slide</p>	<p>FALLING ACTION</p> <p>HORIZONTAL SLIDE FALLING</p> <p>On Horizontal slide fall, their spiral fall</p> <p>Spiral FALL</p> <p>The falling speed is fast</p> <p>Quick slide</p> <p>FAST RETRIEVE</p> <p>IMPACT JERKING</p> <p>Less water resistance by retrieve</p> <p>Quick slide by jerking</p> <p>1 PITCH JERKING</p> <p>Random combination of Straight slide + Spiral action</p>	<p>SHORT SLIDE</p> <p>SHORT DRIFT</p> <p>QUICK FALL</p>	<p>1 PITCH JERKING</p> <p>BACK SLIDE FALL</p> <p>Panic action of bait fish is reproduced with fast back slide fall</p> <p>BITE!</p>

RA-020U DS BASIC SUIT **NEW**



Black Khaki Gray Pacific Camo Red Light Blue Tide Navy



AVAILABLE SIZES: XS, S, M, L, XL, 2XL, 3XL, 4XL

RA-020U DS SHORTS **NEW**



Black Tungsten Dusk Blue



Blue Gray Shade Camo



AVAILABLE SIZES: XS, S, M, L, XL, 2XL, 3XL, 4XL

SH-096U STANDARD T-SHIRT (SHORT SLEEVES) **NEW**



Black White Gray Blue Navy Khaki Heather Gray



AVAILABLE SIZES: XS, S, M, L, XL, 2XL, 3XL, 4XL

SH-076U DRY T-SHIRT (SHORT SLEEVES) **NEW**



Black Heather Gray Heather Blue



AVAILABLE SIZES: XS, S, M, L, XL, 2XL, 3XL, 4XL

SH-174T POLO SHIRT LIMITED PRO (SHORT SLEEVES) **NEW**



Limited Black Limited Red Limited White



AVAILABLE SIZES: S, M, L, XL, 2XL

SH-095U STANDARD T-SHIRT (LONG SLEEVES) **NEW**



Black White Gray Blue Khaki Heather Gray



AVAILABLE SIZES: XS, S, M, L, XL, 2XL, 3XL, 4XL

WEAR SIZE

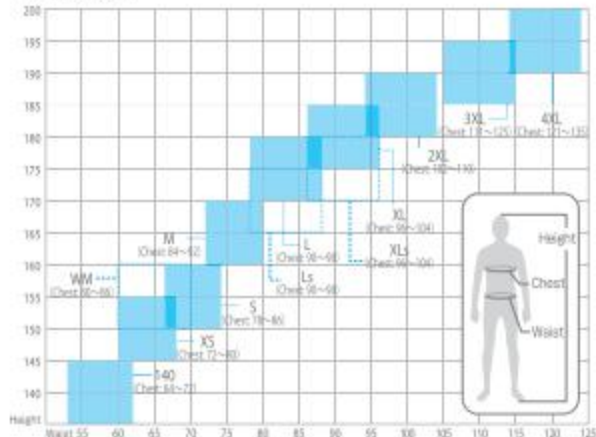

WEAR SIZE

(cm)	140	XS (SS)	WM	S	M	Ls (LS)
Height	135~145	145~155	150~160	150~160	160~170	165~175
Chest	64~72	72~80	80~86	78~86	84~92	90~98
Waist	53~62	60~68	60~70	66~74	72~80	78~88

(cm)	L	XLs (LLS)	XL (LL)	2XL (3L)	3XL (4L)	4XL (5L)
Height	170~180	170~180	175~185	180~190	185~195	190~200
Chest	90~98	96~104	96~104	102~110	111~125 (106~114)	121~135 (110~118)
Waist	78~88	86~96	86~96	94~104	105~115 (100~110)	114~124 (106~116)

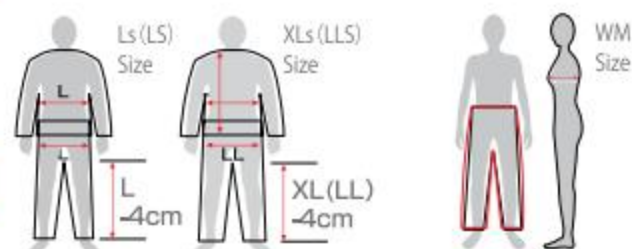

REEL TECHNOLOGY
JDM SPINNING REELS
EXPORT SPINNING REELS
BAITCAST REELS
SW OVERHEAD REELS
ELECTRIC REELS
YUMENA / GLOSSARY
ROD TECHNOLOGY
SALTWATER RODS
BOAT RODS
BASS RODS
SPECIAL RODS
LIFESTYLE GEAR

SH-075U DRY T-SHIRT (LONG SLEEVES)

NEW



Black

Heather Gray

Heather Blue



AVAILABLE SIZES: XS, S, M, L, XL, 2XL, 3XL, 4XL

SH-074U POLO SHIRT (SHORT SLEEVES)

NEW



Black

White

Gray

Blue



AVAILABLE SIZES: XS, S, M, L, XL, 2XL, 3XL, 4XL

WJ-044T SUN PROTECTION PRINT HOODIE

NEW



Black

White



Navy

Shade Camo

Surface Gray



AVAILABLE SIZES: XS, S, M, L, XL, 2XL, 3XL, 4XL

WJ-044T SUN PROTECTION LONG SLEEVE HOODIE SHIRT

NEW



Black

Cool Gray

Charcoal



AVAILABLE SIZES: XS, S, M, L, XL, 2XL, 3XL, 4XL

AC-067Q SUN PROTECTION ARM COVER

NEW



Black

Cool Gray

Ice Blue

White Camo

Shade Camo



FREE SIZE

IN-061Q



Black

Cool Gray

Charcoal

IN-065Q



Black

Cool Gray

Charcoal

IN-061Q SUN PROTECTION LONG SLEEVE SHIRT

NEW



AVAILABLE SIZES: XS, S, M, L, XL, 2XL, 3XL, 4XL

IN-065Q SUN PROTECTION TIGHTS

NEW

AVAILABLE SIZES: XS, S, M, L, XL, 2XL, 3XL, 4XL

AC-067Q SUN PROTECTION ARM COVER

NEW



Black

Cool Gray

Shade Camo



AVAILABLE SIZES: S, FREE SIZE

SH-051 S FULL ZIP PRINT SHIRT (LONG SLEEVE)



Black

White/Red

Red/Black



AVAILABLE SIZES: M, L, XL, 2XL

SH-052S FULL ZIP PRINT SHIRT (SHORT SLEEVE)



Black

White/Red

Red/Black



AVAILABLE SIZES: M, L, XL, 2XL

SOUTH EAST ASIA FISHING WEAR

SHIMANO BASIC TEE

AVAILABLE SIZES: S, M, L, XL, 2XL, 3XL



Black

Back

IT'S ALL ABOUT THE BASS TEE

AVAILABLE SIZES: S, M, L, XL, 2XL, 3XL



Front

Back

FEROCIOUS GROUPEE TEE

AVAILABLE SIZES: S, M, L, XL, 2XL, 3XL



Back

Front

LIVE.BREATHE.FISH HOODIE

AVAILABLE SIZES: S, M, L, XL, 2XL, 3XL



Front

Back

SHIMANO BLACK CAMO HOODIE

AVAILABLE SIZES: S, M, L, XL, 2XL, 3XL



Front

Back

SHIMANO WHITE CAMO HOODIE **NEW**

AVAILABLE SIZES: S, M, L, XL, 2XL, 3XL



Front

Back

CA-046U STANDARD WORK CAP **NEW**



Black

Khaki

Gray

CA-091T FLAT BRIM CAP **NEW**



Black

Navy

Red

Navy

Khaki

CA-041R STANDARD CAP **NEW**



Black

Navy

Khaki

Gray

White

GL-041C POWER FINGER GLOVE **LEZANOVA**



Black

Navy

White

Ocea Black

Ocea Silver White

AVAILABLE SIZES: S, M, L, XL

CA-066T BASIC FLAT CAP **NEW**



Black

Navy

Khaki

Gray/Camo

White/Gray

GL-249R XEFO ROCK GLOVES



AVAILABLE SIZES: M, L, XL

CA-048U STANDARD HAT **NEW**



Black

Navy

Gray

Beige

GL-245S OCEA STRETCH GLOVE GL-255S OCEA STRETCH GLOVE (LONG)



GL-245S

Black

White Navy

GL-255S

Black

White Navy



AVAILABLE SIZES: S, M, L, XL

GL-292T OCEA BIG GAME SUPPORT GLOVE GL-293T OCEA BIG GAME SUPPORT GLOVE (LONG)



GL-292T

Black

White Navy

GL-293T

Black

White Navy



AVAILABLE SIZES: M, L, XL, 2XL

CA-067T BASIC HALF MESH FLAT CAP **NEW**



Black

Navy

Camo/Black

Gray/Black

FS-091I EVAIR MARINE FISHING SHOES **NEW**



Light fishing shoes with excellent sliding resistance.

One shoe for all your aqua-activity needs.

Made from non-marking rubber outsole using ultralight EVA material, the Shimano EVAIR sandals is made for the outdoors. One piece molded EVA absorbs heel shock and reduces foot fatigue with its ergonomic arch design. Now in new colors to suit your preference.

AVAILABLE SHOES SIZES: 7-13

FS-093L EVAIR MARINE FISHING SANDALS



AVAILABLE SHOES SIZES: 7-13

SHIMANO EYEWEAR **NEW**



PC-029R REEL POUCH

M (19x28x13cm)
L (31x41x16.5cm)



BA-038T TACKLE CUSHION BAG **NEW**



M (External: 20x39x24cm, Internal: 19x38x22cm)

L (External: 25x48x31cm, Internal: 24x47x29cm)

BD-021T DAY PACK **NEW**



20L: 16x34x49cm
40L: 21x40x57cm

BA-048T TOTE **NEW**



20L: 22x52x55cm
45L: 27x63x66cm

BW-026T MINI HIP BAG **NEW**



Size: 8x29x18cm

BA-038T TACKLE CUSHION BAG NEW



Size: 8×18×26cm

TH-201M BOBBIN WINDER LIGHT

Light



For PE 0.3-3
Dimension: 75mm

For Shore Lure / Jigging

CT-541P AD PLIER TYPE F

Rust Resistant Fluorine Processing	Compatible Ring #1~#5
PE compatible	

Colours: Black, Blue



WB-024R WAIST BAG NEW



S: 14×27.5×35cm
M: 17×33.5×22cm

For Offshore

CT-561P PLIER FOR OFF SHORE

Rust Resistant Fluorine Processing	Compatible Ring #5~#11
PE Compatible	Straight

Colours: Black, Blue



BK-093T SYSTEM CASE NEW



M: 15×24×9.5cm
L: 19×24×9.5cm
XL: 19×24×18cm
2XL: 24×33×21cm

LG-M: 12×40×9.5cm
LG-L: 12×45×9.5cm
W-M: 24×40×9.5cm

CT-562P POWER PLIER

Rust Resistant Fluorine Processing	Compatible Ring #5~#11
PE Compatible	Bend

Colours: Black, Blue



TH-202N BOBBIN WINDER HEAVY

Heavy



For PE 1.5-8
Dimension: 75mm

Please follow the instructions below to grease fully assembled reels.
IMPORTANT: Grease in a proper position for best results.

● **OILING POINTS**

- : OIL ONLY
- : OIL OR GREASE

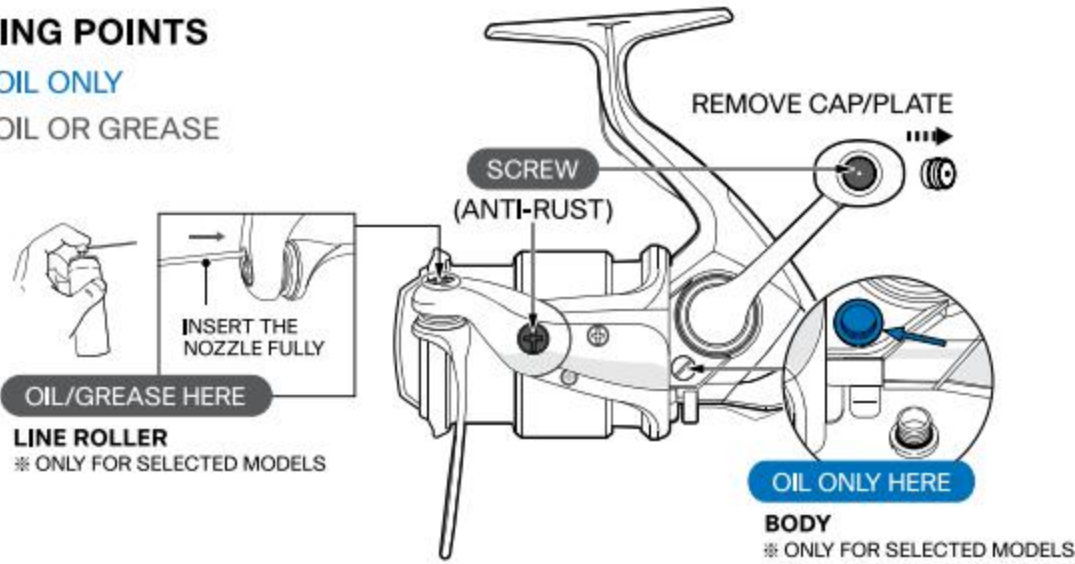

※ ONLY USE GREASE WHEN REEL IS DISASSEMBLED

● **OIL/GREASE POINTS FOR SPINNING REEL**

- : OIL ONLY
- : GREASE ONLY
- : OIL OR GREASE

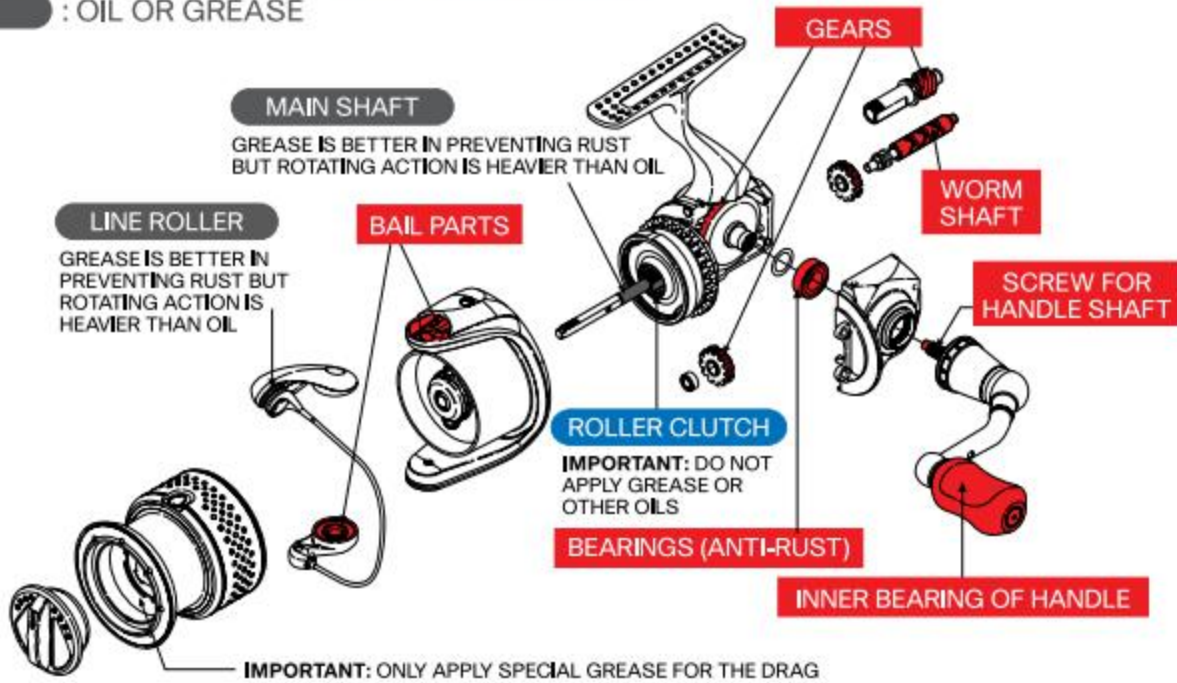

● **OIL/GREASE POINTS FOR BAITCAST REEL**

- : OIL ONLY
- : GREASE ONLY

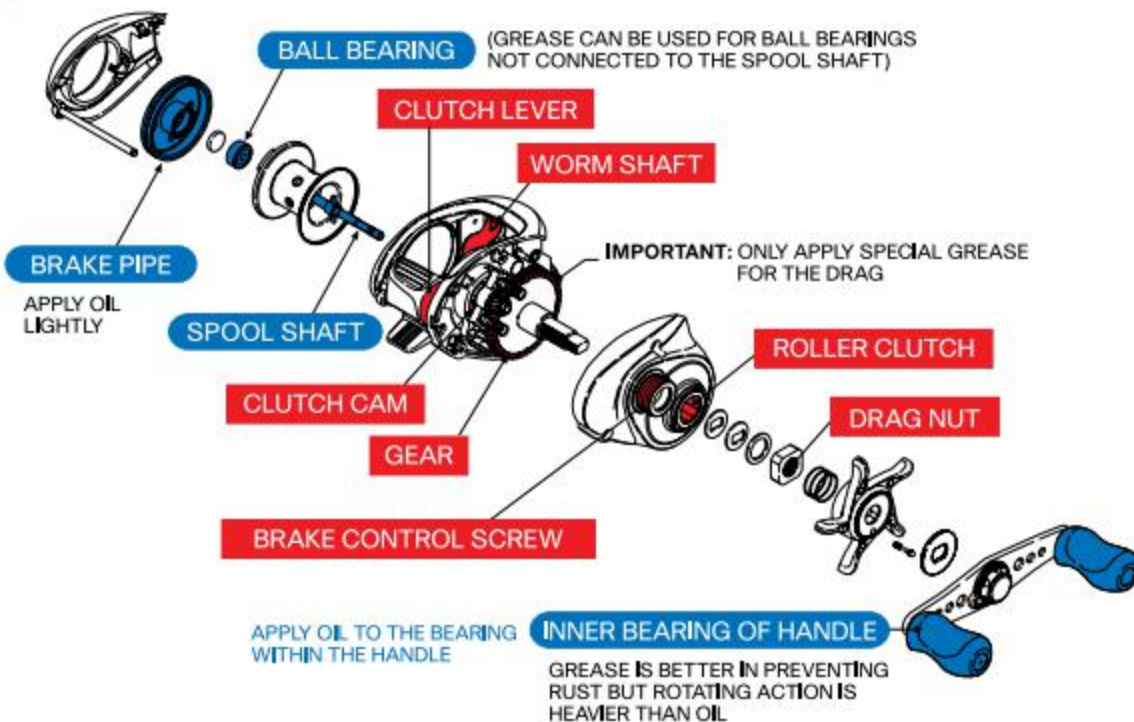

< ATTENTION >
 APPLY OIL/GREASE IN SUITABLE PORTIONS FOR PROPER FUNCTIONING OF REEL
 DISASSEMBLE REEL AT YOUR OWN RISK

REEL
 OIL
 GREASE
 SPRAY
 INSTRUCTION

REEL MAINTENANCE
 SPRAY



SP-013A

SP-213A

SHIMANO



AM I COVERED BY SHIMANO WARRANTY?

Check out our dealer locator for your nearest Shimano Authorised Dealer to be covered under our warranty! Enquire more in stores for details on the warranty coverage. Terms and conditions apply.



SCAN HERE FOR OUR DEALER LOCATOR!
Available on both our website and Facebook page.

**AUTHORISED
WARRANTY PRODUCT**



SHIMANO

SHIMANO (S) PTE LTD

20 Benoi Sector, Jurong Town,
Singapore 629852
fish.shimano.com.sg

SHIMANO INC.

3-77 Oimatsu-cho, Sakai-Ku,
Sakai City, Osaka 590-8577
fishing.shimano.co.jp

SHIMANO NORTH AMERICA HOLDING, INC.

One Holland
Irvine, California, U.S.A, 92618
fish.shimano.com

SHIMANO EUROPE FISHING HOLDINGS B.V.

High Tech Campus 92
NL-5656 AG Eindhoven
The Netherlands
fish.shimano-eu.com

SHIMANO AUSTRALIA

2 Wurrook Circuit,
Caringbah, NSW 2229 Australia
shimanofish.com.au

COPYRIGHT 2021 SHIMANO (SINGAPORE) PTE LTD.

All rights reserved. Nothing in this publication may be reproduced in whole or in part, by any means, without the express permission from Shimano (Singapore) Pte Ltd.

All specifications listed here are subjected to change without prior notice.

Shimano (Singapore) Pte Ltd. handles Shimano Tackles Sales to countries in South East Asia and South Asia through our authorized distributors, wholesalers and dealers.

